











# POE20X

## POE PTZ SMART STREAMING CAMERA

Smooth camera motion control and power by one cable

20X | POE



-   
**FULL HD 1080P**  
 FHD Image
-   
**20X**  
 20X Optical Zoom
-   
**HDMI 3G-SDI LAN**  
 3 Video Output
-   
**POE**  
 POE
-   
**H.264 H.265**  
 Encoding
-   
**Low Light Correction**  
 Low Light Correction
-   
**PTZ**  
 PTZ
-   
**Auto Focus**  
 Auto Focus
-   
**255 Presets**  
 255 Presets
-   
**Remote Control**  
 Remote Control

### >> FEATURES

- 20X optical zoom professional full HD camera , suitable for larger occasion
- Up to 1080p@60fps, higher quality image
- Simultaneous 3G-SDI, HDMI, IP Streaming video out, easily for professional video production
- PoE(Power over Ethernet) supported
- Double track 3.5mm linear input for audio
- Auto focus, smart frame capture everyone
- Supports H.265/H.264 encoding which makes motion video fluent and clear even with less than ideal bandwidth conditions.
- Advanced 2D/3D noise reduction technology further reduces the noise while ensuring high image clarity
- High speed and silent pan/tilt, capture all the actions
- Supports up to 255 presets (10 presets for IR remote control)
- Multiple control protocol and network protocol
- Ideal for church live streaming, video conference, sports events, online education, ect.

### >> EXTERNAL INTERFACE CONNECTION

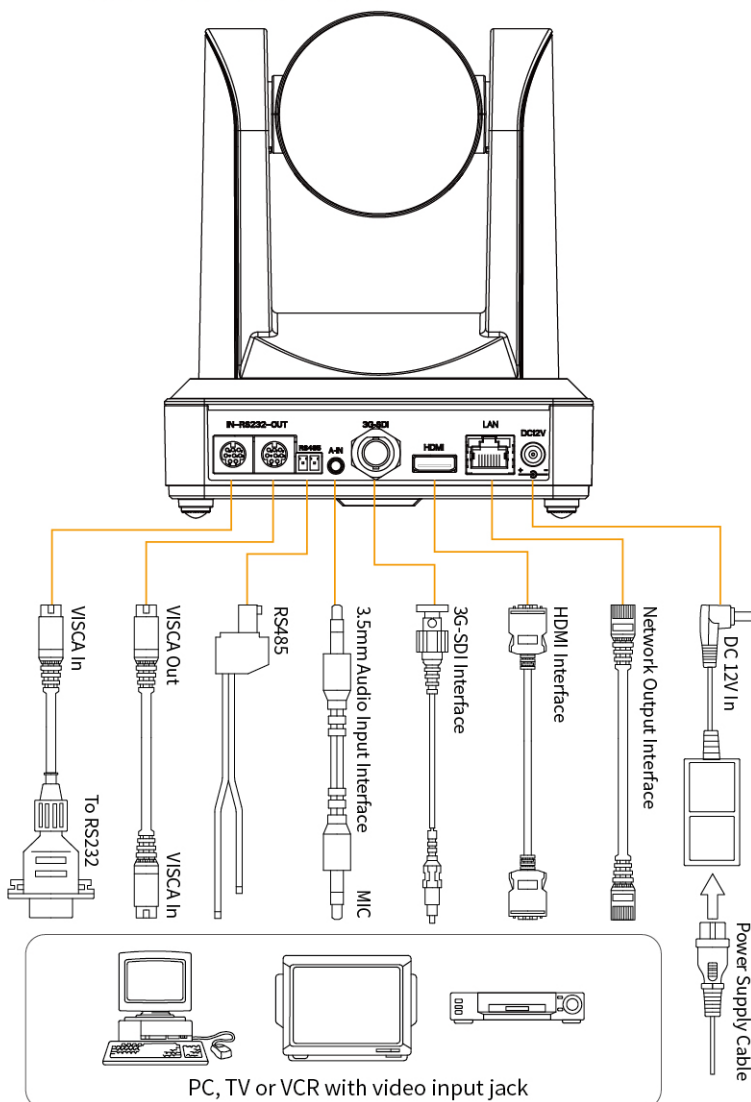

## >> PARAMETER

Description	POE PTZ Camera with 20X Optical Zoom			
Model No.	POE20X			
Connectors	Video(Output)	HDMI	1×HDMI-A	
		SDI	1×BNC	
		LAN(Support PoE)	1×RJ45	
	Audio	1×3.5mm Stereo Jack		
	Communication	RS232	2×DIN 8	
		RS485	1×2 Pin Connector	
	Network	1×100Mbps (10/100BASE-TX)		
	Power	DC 12V		
Optical Zoom	20X f=5.5~110mm			
Camera	View Angle	3.3°~ 54.7°		
	AV	F1.6 ~ F3.5		
	Digital Zoom	20X		
	Minimum Illumination	0.5 lux (F1.8, AGC ON)		
	DNR	2D & 3D		
	White Balance	Auto/Manual/One Push/3000K/3500K/4000K/4500K/5000K/5500K/6000K/6500K/7000K		
	Focus	Auto/Manual		
	Aperture/Electronic Shutter	Auto/Manual		
	WDR	OFF/Dynamic Level Adjustment		
	BLC	ON/OFF		
	Video Adjustment	Brightness/Color/Saturation/Contrast/Sharpness/B/W mode/Gamma curve		
	SNR	>55dB		
	Effective Pixels	2.07m,16:9		
	Pan/Tilt Movement	-170°~+170°/'-30°~+90°		
Pan-and-Tilt Parameter	Pan/Tilt Control Speed	0.1~60°/S ; 0.1~30°/S		
	Preset Speed/Quantity	Pan:60°/S, Tilt:30°/S; Up to 255 preset positions (10 remote control)		
	AAC, MP3, G.711A			
Audio Compression Format	H.264, H.265,Dual Streaming Output			
Video Compression Format	Up to 1080P60 720p25/29.97/30/50/59.94/60   1080p25/30/29.97/30/50/59.94/60			
Output Resolutions	VISCA   Pelco-D   Pelco-P			
Control Protocol	115200   9600   4800   2400bps			
Baud Rate(bps)	RTSP   RTMP   ONVIF   GB/T28181   VISCA			
Network Protocol	HDMI 1.3			
Supported Standards	SDI SMPTE 425M (Level A & B)   SMPTE 424M   SMPTE 292M   SMPTE 259M-C   DVB-ASI			
	NDI NDI HX low bandwidth version			
Input Voltage	DC12V/1.5A			
Max Power	12W			
Temperature	-10°C~50°C			
Humidity	20%~80%			
Unit Weight	1.4kg			
Unit Size	150mm×150mm×167.5mm			

## >> STRUCTURE

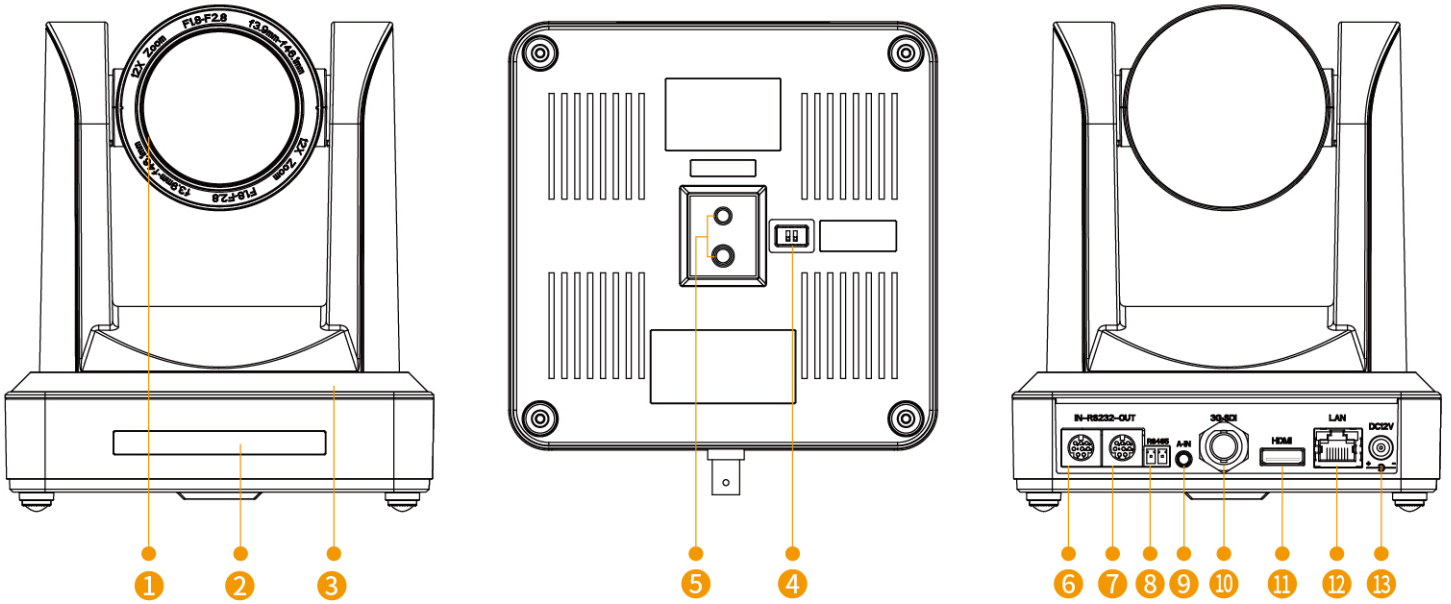

① Camera Lens	⑥ RS232 Control Interface (input )	⑪ HDMI Interface
② Camera Base	⑦ RS232 Control Interface (output)	⑫ 10/100M Network Interface
③ Remote Controller Receiver Light	⑧ RS485 Input (left +,right - )	⑬ DC12V Input Power Supply Socket
④ Bottom Dial Switch	⑨ Audio Input Interface	
⑤ Tripod Screw Hole	⑩ 3G - SDI interface	

## >> PACKING LIST

			
POE20X PTZ Camera	Remote Control	RS232 Control Cable	RS485 Terminal Block
			
Power Adapter	US Standard Power Cable	EU Standard Power Cable	User manual



Zhangzhou Seetec Optoelectronics Technology Co., Ltd

E-mail: sales@feelworld.cn

Tel: +86-596-2672627

Website: www.feelworld.com.cn

Fax: +86-596-2672617

www.seetec.com.cn