

USB10X

USB PTZ SMART VIDEO CAMERA

One solution for better collaboration | Record every important moment

10X | USB2.0



- 
FULL HD 1080P
 FHD Image
- 
10X
 10X Optical Zoom
- 
 Plug and Play
- 
 PTZ
- 
 Auto Focus
- 
 70°
 Wide View Angle
- 
 255 Presets
- 
 Remote Control

>> FEATURES

- 10X optical zoom Professional conferencing Camera for Business Meetings, you'll feel like you're face-to-face in the same room.
- USB2.0 video out, plug and play, anyone can easily setup and control
- Support 1080p@30fps, realize a life-like video experience
- Auto focus, smart frame capture everyone
- 70° wide viewing angle, ideal for various meetings
- Advanced 2D/3D noise reduction technology further reduces the noise while ensuring high image clarity
- High speed and silent pan/tilt, capture all the actions
- Supports up to 255 presets (10 presets for IR remote control)
- Multiple Control Protocol and interfaces
- Ideal for video conference, live streaming, medical seminar, online education, ect.



>> EXTERNAL INTERFACE CONNECTION

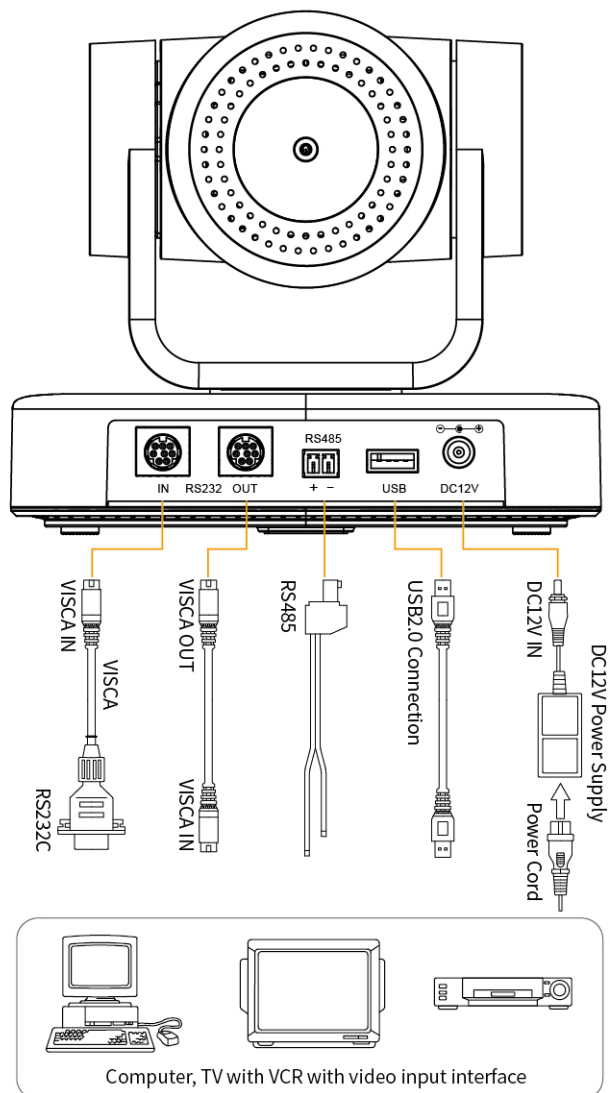

>> PARAMETER





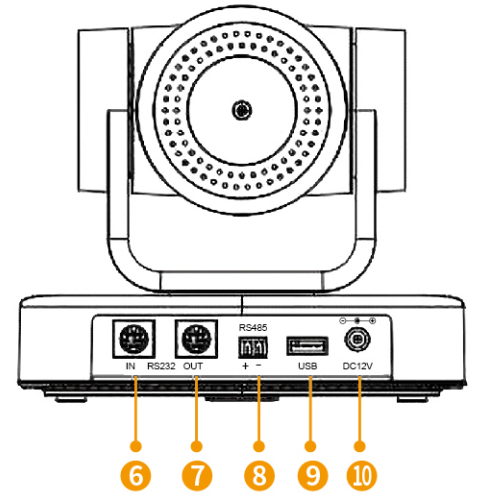
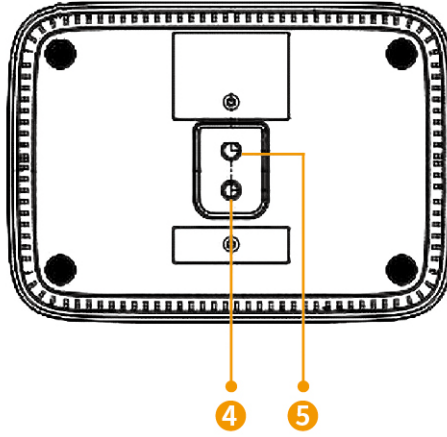
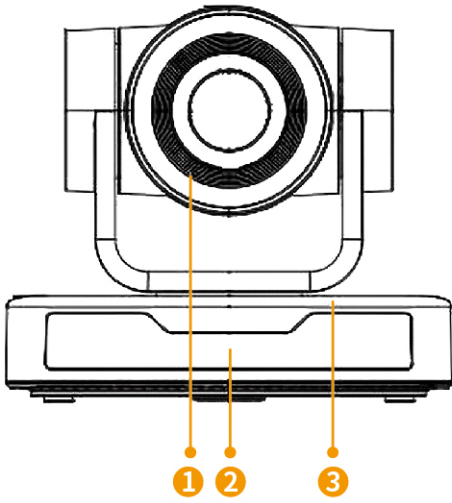



Description	USB PTZ Camera with 10X Optical Zoom		
Model No.	USB10X		
Connectors	Video(Output)	USB2.0	1×USB-A
	Communication	RS232	2×DIN 8
		RS485	1×2 Pin Terminal Connector
	Power	DC 12V	
Camera	Optical Zoom	10X f=4.34~41.66mm	
	View Angle	8.8°~ 70°	
	AV	F1.85 ~ F2.43	
	Digital Zoom	10X	
	Minimum Illumination	0.5 lux (F1.8, AGC ON)	
	DNR	2D & 3D	
	White Balance	Auto/Manual/One Push/3000K/3500K/4000K/4500K/5000K/5500K/6000K/6500K/7000K	
	Focus	Auto/Manual/One Push	
	Exposure	Auto/Manual	
	BLC	ON/OFF	
	Video Adjustment	Brightness/Color/Saturation/Contrast/Sharpness/B/W mode/Gamma curve	
	SNR	>55dB	
	Effective Pixels	2.07m,16:9	
Pan-and-Tilt Parameter	Pan/Tilt Movement	-170°~+170°/'-30°~+90°	
Video Compression Format	Pan/Tilt Control Speed	0.1~60°/S;0.1~30°/S	
	Preset Speed/Quantity	Pan:60°/S, Tilt:30°/S; Up to 255 preset positions (10 remote control)	
	MJPG H.264 H.265		
Output Resolutions	720p@25/30 1080p@25/30		
Control Protocol	VISCA Pelco-D Pelco-P		
Operating System	Windows 7 Windows8 Windows10 Mac osx Linux		
USB Communication Protocol	UVC		
Input Voltage	DC12V/0.25A		
Max Power	2.5W		
Temperature	-10°C~50°C		
Humidity	20%~80%		
Unit Weight	1kg		
Unit Size	156.8mm×112.6mm×139.5mm		

>> STRUCTURE



1 Camera Lens	5 Screw Hole for Tripod	9 USB 2.0 Interface
2 Remote Control Receiving Indicator	6 RS232 Control Interface (Input)	10 DC12V Input Power Supply Socket
3 Camera Base	7 RS232 Control Interface (Output)	
4 Tripod Screw Hole	8 RS485 Input (left +, right-)	

>> PACKING LIST

 USB10X PTZ Camera	 Remote Control	 USB2.0 Cable
 RS232 Control Cable	 RS485 Terminal Block	 Power Adapter
 US Standard Power Cable	 EU Standard Power Cable	 User manual



Zhangzhou Seetec Optoelectronics Technology Co., Ltd

E-mail: sales@feelworld.cn

Tel: +86-596-2672627

Website: www.feelworld.com.cn

Fax: +86-596-2672617

www.seetec.com.cn