

datavideo

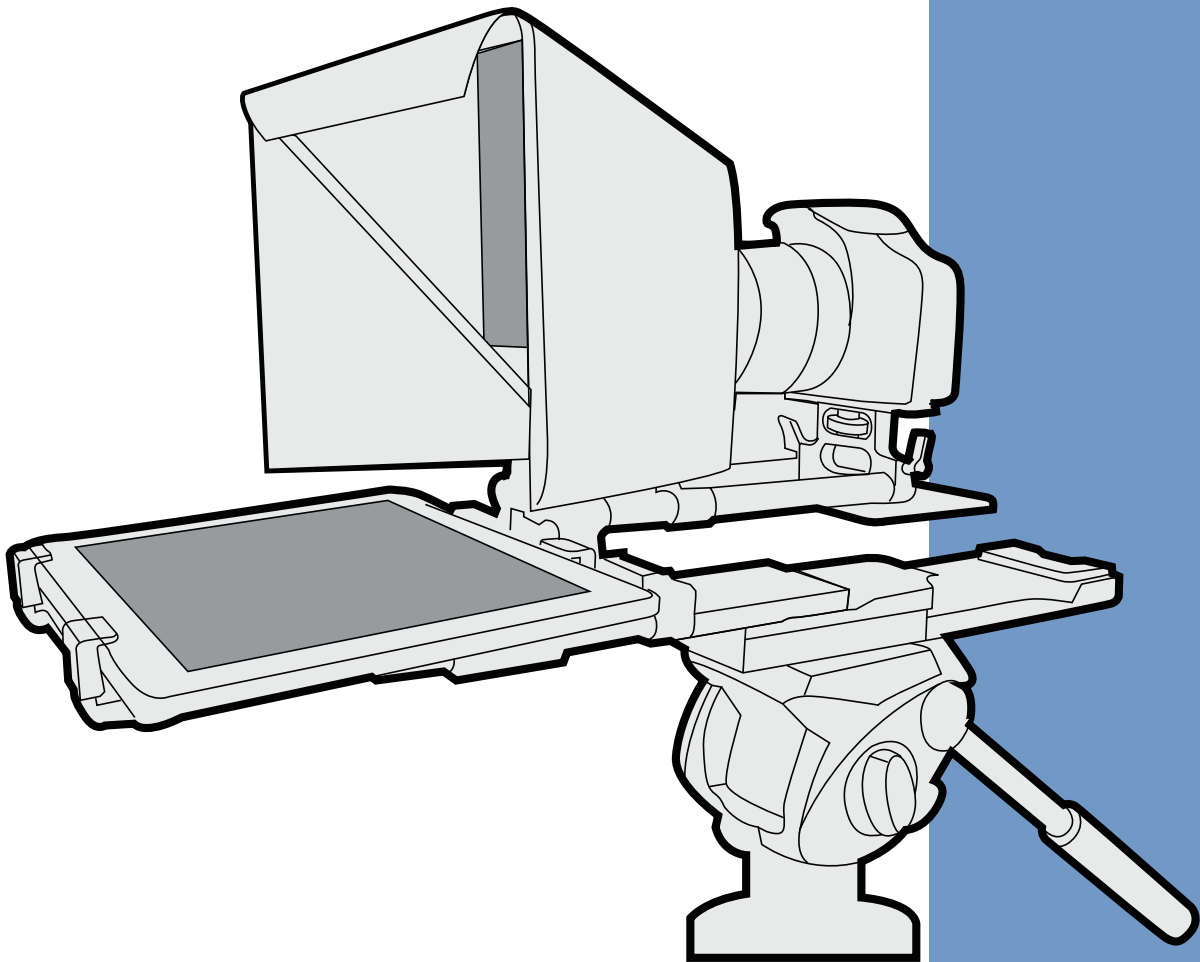

**DSLR PROMPTER
TP-500
Instruction manual**

www.datavideo.com

Contents

FCC COMPLIANCE STATEMENT	3
WARNINGS AND PRECAUTIONS.....	3
GLASS – HANDLE WITH CARE	3
WARRANTY	4
STANDARD WARRANTY.....	4
REGISTER FOR 3 YEAR WARRANTY.....	4
DISPOSAL	4
PACKING LIST.....	5
PRODUCT OVERVIEW	6
FEATURES.....	6
ASSEMBLY – TP-500.....	7
CAMERA EXPOSURE AND THE 60/40 GLASS.....	11
ADJUSTABLE CAMERA PLATFORM	12
CLEANING THE 60/40 GLASS	13
FREE APP DOWNLOAD FROM THE APP STORE™	14
FREE ANDROID APP DOWNLOAD FROM GOOGLE PLAY™	14
OPTIONAL REMOTE CONTROL MANUAL	14
OPTIONAL BLUETOOTH TELEPROMPTER REMOTE CONTROL.....	15
REMOTE STARTS IN WIRED MODE.....	15
BLUETOOTH MODE – PAIRING TO YOUR TABLET DEVICE.....	15
<i>RESET – Return the Remote to Wired Mode</i>	16
CONTROL BUTTONS.....	17
REMOTE ACCESSORIES	17
<i>Lanyard Necklace</i>	17
<i>CR2032 Battery</i>	18
DVPROMPTER PLUS APP.....	19
DOCUMENTS SCREEN	19
CREATING AND EDITING SCRIPTS.....	20
<i>On the device</i>	20
<i>Via the web interface (Requires webui In-app purchase)</i>	21
PLAYLISTS (REQUIRES WEBUI IN-APP PURCHASE).....	22
<i>Adding a script to the playlist</i>	22
<i>Changing the playlist order</i>	22
CONTROL	23
<i>Via the device (on screen)</i>	23
<i>Via the web interface (Requires webui In-app purchase)</i>	24
<i>Using the WR-500</i>	25
MENU BAR.....	26
<i>Settings</i>	27
<i>Network (Requires webui In-app purchase)</i>	30
SYNCHRONIZING MULTIPLE DEVICE (REQUIRES WEBUI IN-APP PURCHASE)	32
CONNECTING AN EXTERNAL DISPLAY	34
OPTIONAL HC-500 HARD CASE.....	35
HC-500 FEATURES	35
HC-500 SPECIFICATIONS.....	35

FREQUENTLY ASKED QUESTIONS36
SPECIFICATIONS.....36
SERVICE AND SUPPORT39

Disclaimer of Product and Services

The information offered in this instruction manual is intended as a guide only. At all times, Datavideo Technologies will try to give correct, complete and suitable information. However, Datavideo Technologies cannot exclude that some information in this manual, from time to time, may not be correct or may be incomplete. This manual may contain typing errors, omissions or incorrect information. Datavideo Technologies always recommend that you double check the information in this document for accuracy before making any purchase decision or using the product. Datavideo Technologies is not responsible for any omissions or errors, or for any subsequent loss or damage caused by using the information contained within this manual. Further advice on the content of this manual or on the product can be obtained by contacting your local Datavideo Office or dealer.

FCC Compliance Statement

This device complies with part 15 of the FCC rules. Operation is subject to the following two conditions:

1. This device may not cause harmful interference, and
2. This device must accept any interference received, including interference that may cause undesired operation.

Warnings and Precautions



1. Read all of these warnings and save them for later reference.
2. Follow all warnings and instructions marked on this unit.
3. Unplug this unit from the wall outlet before cleaning. Do not use liquid or aerosol cleaners. Use a damp cloth for cleaning.
4. Do not use this unit in or near water.
5. Do not place this unit on an unstable cart, stand, or table. The unit may fall, causing serious damage.
6. Slots and openings on the cabinet top, back, and bottom are provided for ventilation. To ensure safe and reliable operation of this unit, and to protect it from overheating, do not block or cover these openings. Do not place this unit on a bed, sofa, rug, or similar surface, as the ventilation openings on the bottom of the cabinet will be blocked. This unit should never be placed near or over a heat register or radiator. This unit should not be placed in a built-in installation unless proper ventilation is provided.
7. This product should only be operated from the type of power source indicated on the marking label of the AC adapter. If you are not sure of the type of power available, consult your Datavideo dealer or your local power company.
8. Do not allow anything to rest on the power cord. Do not locate this unit where the power cord will be walked on, rolled over, or otherwise stressed.
9. If an extension cord must be used with this unit, make sure that the total of the ampere ratings on the products plugged into the extension cord do not exceed the extension cord rating.
10. Make sure that the total amperes of all the units that are plugged into a single wall outlet do not exceed 15 amperes.
11. Never push objects of any kind into this unit through the cabinet ventilation slots, as they may touch dangerous voltage points or short out parts that could result in risk of fire or electric shock. Never spill liquid of any kind onto or into this unit.
12. Except as specifically explained elsewhere in this manual, do not attempt to service this product yourself. Opening or removing covers that are marked "Do Not Remove" may expose you to dangerous voltage points or other risks, and will void your warranty. Refer all service issues to qualified service personnel.
13. Unplug this product from the wall outlet and refer to qualified service personnel under the following conditions:
 - a. When the power cord is damaged or frayed;
 - b. When liquid has spilled into the unit;
 - c. When the product has been exposed to rain or water;
 - d. When the product does not operate normally under normal operating conditions. Adjust only those controls that are covered by the operating instructions in this manual; improper adjustment of other controls may result in damage to the unit and may often require extensive work by a qualified technician to restore the unit to normal operation;
 - e. When the product has been dropped or the cabinet has been damaged;
 - f. When the product exhibits a distinct change in performance, indicating a need for service.

GLASS – Handle with care



This product contains a sheet of 60/40 mirror glass please handle it with care.

To avoid a risk of damage or injury please follow this instruction manual and use caution when transporting, un-packing, cleaning, assembling or dis-assembling this part of the product.

Warranty



Standard Warranty

- Datavideo equipment are guaranteed against any manufacturing defects for one year from the date of purchase.
- The original purchase invoice or other documentary evidence should be supplied at the time of any request for repair under warranty.
- The product warranty period begins on the purchase date. If the purchase date is unknown, the product warranty period begins on the thirtieth day after shipment from a Datavideo office.
- All non-Datavideo manufactured products (product without Datavideo logo) have only one year warranty from the date of purchase.
- Damage caused by accident, misuse, unauthorized repairs, sand, grit or water is not covered under warranty.
- Viruses and malware infections on the computer systems are not covered under warranty.
- Any errors that are caused by unauthorized third-party software installations, which are not required by

our computer systems, are not covered under warranty.

- All mail or transportation costs including insurance are at the expense of the owner.
- All other claims of any nature are not covered.
- All accessories including headphones, cables, and batteries are not covered under warranty.
- Warranty only valid in the country or region of purchase.
- Your statutory rights are not affected.

Register for 3 year Warranty

- All Datavideo products purchased after July 1st, 2017 are qualified for a free two years extension to the standard warranty, providing the product is registered with Datavideo within 30 days of purchase.
- Certain parts with limited lifetime expectancy such as LCD panels, DVD drives, Hard Drive, Solid State Drive, SD Card, USB Thumb Drive, Lighting, Camera module, PCIe Card are covered for 1 year.
- The three-year warranty must be registered on Datavideo's official website or with your local Datavideo office or one of its authorized distributors within 30 days of purchase.

Disposal

For EU Customers only - WEEE Marking

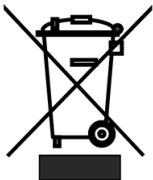

This symbol on the product or on its packaging indicates that this product must not be disposed of with your other household waste. Instead, it is your responsibility to dispose of your waste equipment by handing it over to a designated collection point for the recycling of waste electrical and electronic equipment. The separate collection and recycling of your waste equipment at the time of disposal will help to conserve natural resources and ensure that it is recycled in a manner that protects human health and the environment. For more information about where you can drop off your waste equipment for recycling, please contact your local city office, your household waste disposal service or the shop where you purchased the product.



CE Marking is the symbol as shown on the left of this page. The letters "CE" are the abbreviation of French phrase "Conformité Européene" which literally means "European Conformity". The term initially used was "EC Mark" and it was officially replaced by "CE Marking" in the Directive 93/68/EEC in 1993. "CE Marking" is now used in all EU official documents.

Packing List

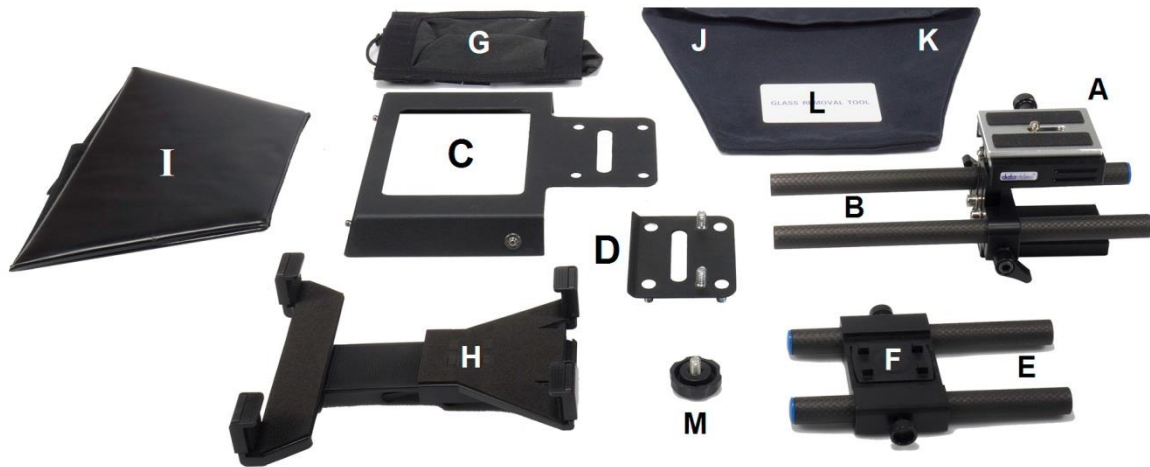

Item	Description	Quantity
A	Adjustable Camera Plate	1
B	15mm Carbon fibre rod Length 230mm	2
C	Hood Frame with square hole and Velcro straps for item G. Hood Frame also has press studs for item I.	1
D	Screw plate for securing items B, C, D and E together.	1
E	15mm Carbon fibre rod Length 150mm	2
F	Mounting plate with hooks for adjustable tablet holder item H	1
G	Lens snood with pull cord and Velcro straps for item C	1
H	Adjustable tablet holder	1
I	Folding hood with press studs and velcro strap for item J	1
J	Velcro edged 60/40 Mirror glass with green and red stickers	1
K	Micro fibre cloth pouch to hold items J & L when packed.	1
L	Plastic card glass removal tool	1
M	Spare screw to secure the hook plate to item F	1
O	Hex tool for screws in item A	1
plus	Retail carton with protective foam packing	1

NOTE: Depending on your order, your TP-500 kit could have been supplied with one of a range of wired or Bluetooth remote controls – for more information on the remote controls please speak with your local Datavideo supplier or check our website www.datavideo.info for details.

NOTE: The foam packing within this products retail carton has been designed so that it can be easily transferred to an **optional** hard case, called **HC-500**, for this kit. See page 18 for more information.

Please speak with your supplier if you wish to purchase an optional remote control or hard case for your prompter kit.



Shown with Canon EOS 550D

Product Overview

Why struggle with expensive re-takes, on stage talent drifting off script or a presenters' loss of eye contact with the viewing audience? This Datavideo Prompter Kit is designed to help you overcome these problems by converting a tablet computer (*not supplied*) into a low cost and effective prompter.

The Datavideo Prompter Kit, TP-500, can be used in either a theatre setting, or a video studio. Prepared scripts or cue sheets can be easily copied and pasted into the DV prompter app software from email and scrolled at a set automatic rate or controlled by a user with the optional wired / wireless remote for a more natural result. A number of clear fonts, colours and text sizes are available making reading comfortable from a variety of distances.

That's Datavideo, sharing the value !

Features

- Simple software and remote allow users to produce professional results at low cost.
- Special 60/40 Glass allows the presenter to read the script and the camera to see the subject.
- Strong and rigid prompter frame fixes securely to any standard tripod quick release plate.
- The prompter frame is designed to allow in front of camera lens prompting.
- The black camera snood/hood is adjustable to adapt for a wide variety of cameras.
- Quick and simple assembly that requires no special tooling.
- Expandable mounting bracket system allows simple but secure installation of tablet.
- An **optional** remote control is available.

Assembly – TP-500



1. Attach/screw the tripod's own quick release plate to the screw holes on the base of the TP-500 adjustable Camera plate, **Item A**.

Tip: Add a second screw (not supplied) through the tripod's quick release plate. This to stop **Item A** from being able to spin on top of the tripod quick release plate.



2. Now slide and secure the tripod plate, with **Item A** on top, onto the head of the tripod or dolly.

3. Remove the sliding camera plate from the top of **Item A**. Do this by pressing in the side screw on **Item A** once it has been unscrewed half way.



4. Attach the camera plate from **Item A** to the base of the DSLR camera. Now slide the camera and plate into position on top of **Item A**.



5. Now slide the camera and plate back into position on top of **Item A**.



6. There are four adhesive Velcro straps packed inside the kit. Peel off the white paper backing before applying these straps to the Hood Frame, **item C**.

Apply the two long Velcro strips to the Inside edges on the Left side and Right side of the hole for the lens. Then apply the two smaller Velcro strips to the top and bottom sides of the lens hole.



7. Screw **rod items E** to **plate item D**. Rod Items E screw to the front side of the plate D, this side only has two screw threads.

The bent edge of plate item D is the top edge.

The rear side of plate item D has four screw threads.



8. Marry **item C**, the Hood frame, to plate **item D** using the four holes in item C and the four screw threads on item D.

9. **Secure item C to D** by screwing **rod items B** on to the upper two screw threads for a normal DSLR configuration.

NB: If the DSLR camera is fitted with a battery pack under it, then rod items B are screwed to the lower two threads instead.



10. Marry or slide the blue ends of **rod items B** in to the **rod clamps on item A**. Slide the rods in until the camera lens is about 1 or 2 centimetres away from the hole in the hood frame, **item C**.



11. Now clamp the rods in place.



12. Now add the cloth lens snood, **Item G**, by marrying the velcro straps on the snood to the Velcro straps on the Hood frame, **Item C**. The cloth tube of the Lens Snood, **Item G**, should surround the lens.



13. The snood pull cord and toggle can then be used to tighten the snood around the lens to shut out light from the camera side.

Be careful not to change the lens settings from the desired shot.

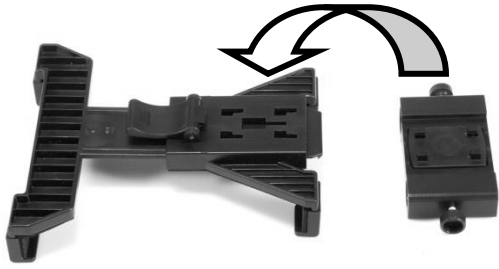

14. Marry the bottom of the adjustable tablet holder, **Item H**, to the four hooks in the top of **Item F**.

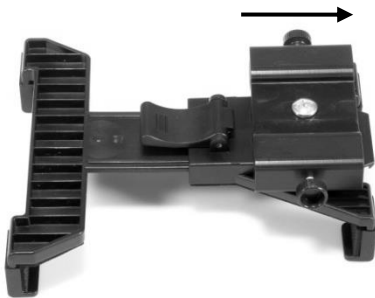
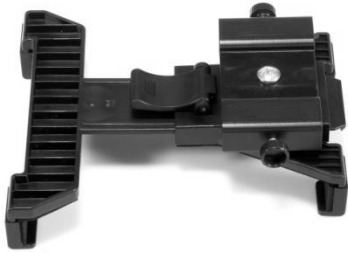

15. Then slide **item F** until it clicks into its secured position on the bottom of **item H**.



16. Now slide **items F and H**, the right way up, into place on the shorter **rod items E**.



17. Secure the folding hood, **item I**, using the press studs on the hood and frame.



18. Now insert the Mirror glass, **Item J**. There are Velcro edges to the glass, marry these edges to the Velcro on **Items C (bottom)** and **I (top)** so it is secure. The shortest edge of the Mirror glass should be at the bottom.

NOTE: The glass has a **red** and a **green circle sticker** in one corner. The glass should be fitted with the **green circle towards the subject** and the **red circle towards the camera lens**.



19. Turn on the tablet or mobile device being used, Install and launch the **DV Prompter** software, See separate DV Prompter manual and prepare the prompting text to be used.

20. Now set up the DV Prompter app for the chosen optional remote control type.



21. Put the configured tablet into the mounting bracket and ensure it is held securely by adjusting the size of the bracket holders for a snug fit and locking them in place. Use the locking lever on the bottom of **item H**.

22. Adjust the prompting settings where necessary.
 23. Adjust the camera exposure settings as necessary. See **Camera Exposure** below.
 24. Read the separate manual regarding your optional remote control or the [Optional Bluetooth Teleprompter Remote Control](#) section in this manual.

Camera Exposure and the 60/40 Glass

After setting up the camera with the 60/40 glass in front of the lens adjust the camera set up and white balance. This is because the 60/40 Glass affects the camera exposure by approximately 1 stop almost like the effect of a neutral density filter. Consult your camera manual for further help and advice with its exposure and white balance settings.

Adjustable camera platform

The adjustable camera platform has three hex head screws on its rear for reconfiguring the camera position in a number of ways. The Hex tool, item O, is provided for this purpose.

The two lower hex head screws can be used to adjust the height of the TP-500 rails in relation to the DSLR camera or lens.

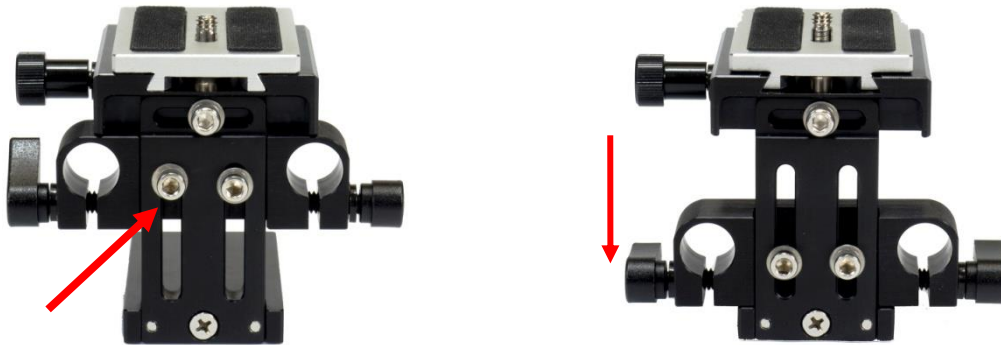

The top centre hex screw can be used to adjust the DSLR camera platform left or right.



The top centre hex screw can also be removed and the camera platform relocated to the opposite side of the spine. This can be useful when using slightly longer lenses on the DSLR camera.



Note: Leave the thumb screws loose when the 15mm rails are not fitted to the camera platform.

Cleaning the 60/40 Glass

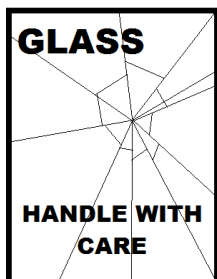

This product contains a sheet of 60/40 glass please handle it with care.

To avoid a risk of damage or injury please follow this instruction manual and use caution when transporting, un-packing, cleaning, assembling or dis-assembling this part of the product.

Datavideo recommend cleaning the glass regularly to remove dust and finger print marks. This will ensure the best image quality is recorded when the camera is looking through the glass.

Never attempt to clean the glass whilst it is mounted in the prompter instead remove it carefully from the prompter, clean the glass and then re-install it into the prompter frame. Handle the glass carefully using the cloth covered edges of the glass at all times.

To retain the required qualities of the glass and to avoid scratching the glass during cleaning.

- **Never use** abrasive cloths, pads or abrasive based cleaning fluids on the glass.
- **Never use** cleaning fluids based on an acid or vinegar solution.

Place the glass on a soft, stable, dirt and lint free work surface such as a table with a clean cloth already laid out on it. Then use a second clean, lint free, soft cloth to clean the glass.

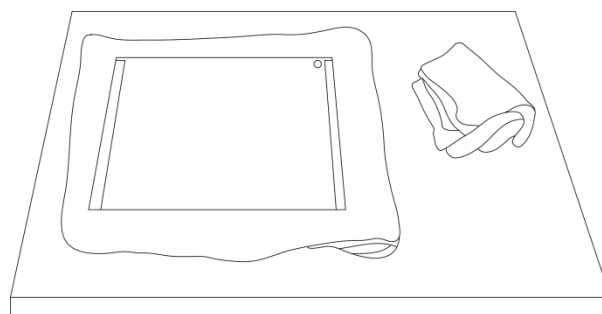

Do not apply cleaning fluids to the glass directly, instead apply or spray a small amount of the cleaning fluid onto the cloth. Proceed to clean the glass and work in a light circular motion with the cloth. Ensure all finger marks and streaks are gone before turning the glass over and repeating with the other side.

Once finished re-install the glass back into the prompter hood, again using the cloth covered edges only. **Ensure the green circle sticker on the glass is facing you** and the red circle sticker is facing the camera lens. Reseat/secure the camera hood if necessary.

Free app download from the App Store™

Ensure your tablet has internet access via your cellular service provider or a secure wireless connection.

Tap the **App Store™ icon** on the device Home Screen



to download apps wherever you are.

Browse the section of the store that features apps designed specifically for these devices or tap on the **Search Bar**

at the top/bottom of the screen and type in **dv Prompter Plus**. Then execute the search by tapping on the Search icon to the right. You will see the app, **dvPrompter Plus**. Simply tap on the **Free** icon next to dvPrompter Plus and then **Install**.

The App Store icon on your device will show you when



an update is available for any app that you already have. Install the updates with a tap, and you'll always have the latest version of your favourite apps like

DV Prompter Plus.

Free Android App download from Google play™

Ensure your tablet has internet access via your cellular service provider or a secure wireless connection.



Tap on the **Play**

Store™ icon on the

device Home Screen

to see the latest or

popular **App** downloads. Tap the **Search Bar** at the top of the screen and type in **dv Prompter Plus**. Then execute the search by tapping on the magnifying glass icon to the right.

You will see the app, **dvPrompter Plus**. Simply tap on dvPrompter Plus and choose **install**.

Android and Google play are trademarks of Google Inc.

Optional remote control manual

See the following section, [Optional Bluetooth Teleprompter Remote Control](#), which covers how to use the remote control. There is also a separate manual supplied with the remote control and can also be downloaded as a PDF document from your local Datavideo office website.

Optional Bluetooth Teleprompter Remote Control

This **WR-500** remote control is designed to be used with Datavideo's teleprompter products, **DV Prompter** and **DVP-100**.

DV Prompter Plus app is a FREE download from the Apple app store for iOS devices and also from Google Play for Android devices. **DVP-100** is a synchronised, multi tablet / camera, teleprompting product.

A separate manual is provided for DVP-100 and the DV Prompter app. For further details please visit our website www.datavideo.com

Remote starts in Wired Mode

When first removed from the retail package the WR-500 remote is already in **wired mode**. When a button is pressed a **RED LED** will flash. The WR-500 can be switched to Bluetooth mode if required.

In wired mode, the remote needs to be physically cabled to the tablet it is controlling. A four pole jack to jack plug cable is provided with this remote.

One end of the cable fits into the tablet's headset socket. The other end plugs into the jack socket on the WR-500 remote.



NOTE: When using this remote in wired mode the **DV Prompter Plus app** should also be set to **Wired – WR-500** in the **Remote menu option**.

Bluetooth Mode – Pairing to your tablet device

Switch the **Bluetooth** function **ON** within the **tablet device settings**.

Open the DV Prompter app on the same tablet device and choose **Bluetooth – WR-500** in the **Remote Control menu**.

Select and start the required script within the DV Prompter Plus app.

To switch the remote into Bluetooth pairing mode press and hold the centre Play / Pause button for 3 to 4 seconds.

The **GREEN LED** will now blink on / off repeatedly to indicate it is ready to pair with a Bluetooth device.



Once paired a Bluetooth icon will be shown in the top right hand corner of the main app screen and bottom right corner of the script.

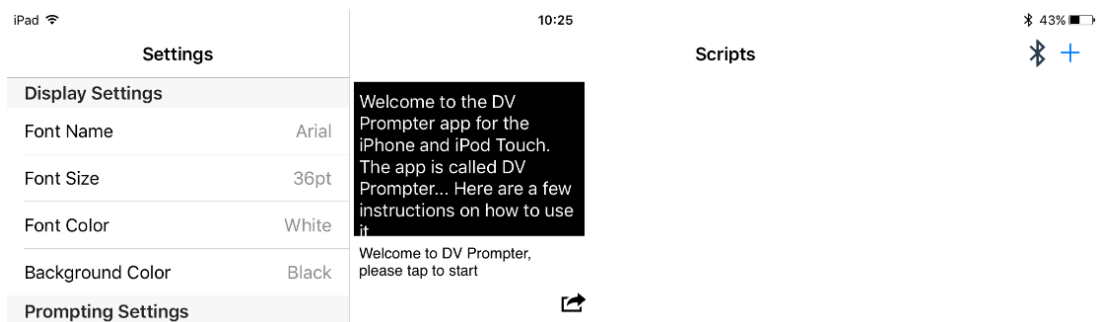

for the iPhone and iPod Touch. The

Note: The remote will sleep after 5 minutes of inactivity to save battery life. Press the play / pause button to wake the remote and it will automatically try to re-pair with the tablet previously used.

RESET – Return the Remote to Wired Mode

To return the WR-500 remote to wired mode from Bluetooth mode simply **press and hold the Play / Pause button until the GREEN LED stops flashing** and becomes a steady GREEN light.

When a **RED** LED is shown on button presses the remote is in wired mode.

Control Buttons

Button	Whilst scrolling text	Whilst text paused
+	Speed up text scroll	Next Break Marker
-	Slow down text scroll	Previous Break Marker
▶	Pause text	Play text
◀◀	Reduce font size	Load previous script
▶▶	Increase font size	Load next script

LED Indicators

RED LED	Wired Mode
GREEN LED	Bluetooth 4

Remote Accessories

Lanyard Necklace



Plug the lanyard necklace into the jack plug socket.

CR2032 Battery

A **CR2032 button battery** is installed inside this remote. The original battery supplied (when new) is expected to last for 3 years under average / normal use.

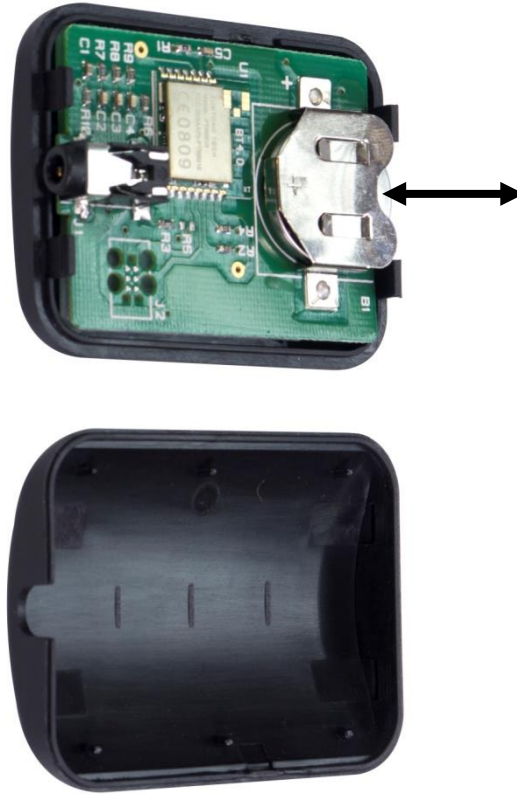

This button battery can be replaced by the user when it dies. **Please remove the back case cover carefully** to avoid user damage to the PCB or case. Then slide the old battery out.

Please ensure the new button battery is installed with the positive (+) side of the cell facing the (+) sign on the PCB battery slot.

dvPrompter Plus App

Documents Screen

When you first launch the app, you will see the screen below.

The menu bar in the top left-hand corner provides access to the various settings menus.

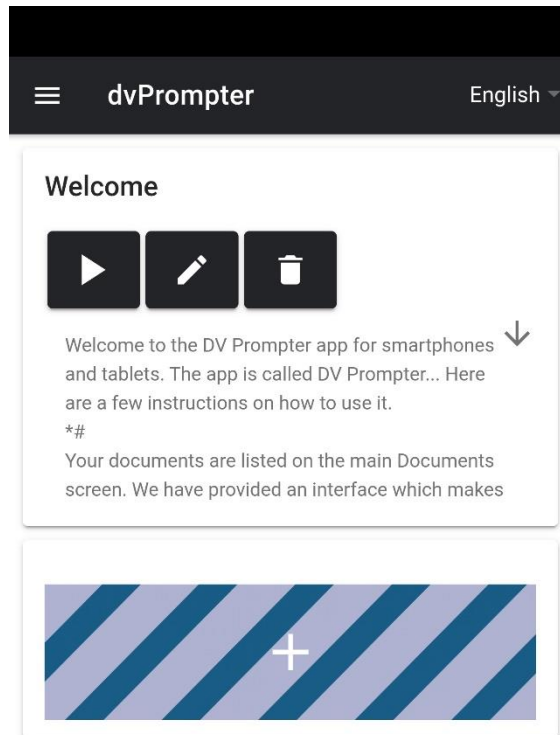

Creating and Editing Scripts

On the device

To create a new script on the device simply tap the '+' button, enter a title and then enter the script body into the rich text editor. The script will be saved automatically when you close the rich text editor by tapping the blue 'X'.

To edit a script on the device simply tap the 'Edit' button, the script will be saved automatically when you close the rich text editor by tapping the blue 'X'.

Please note: The default set in the main settings menu can be overridden on a per script basis from within the editor.

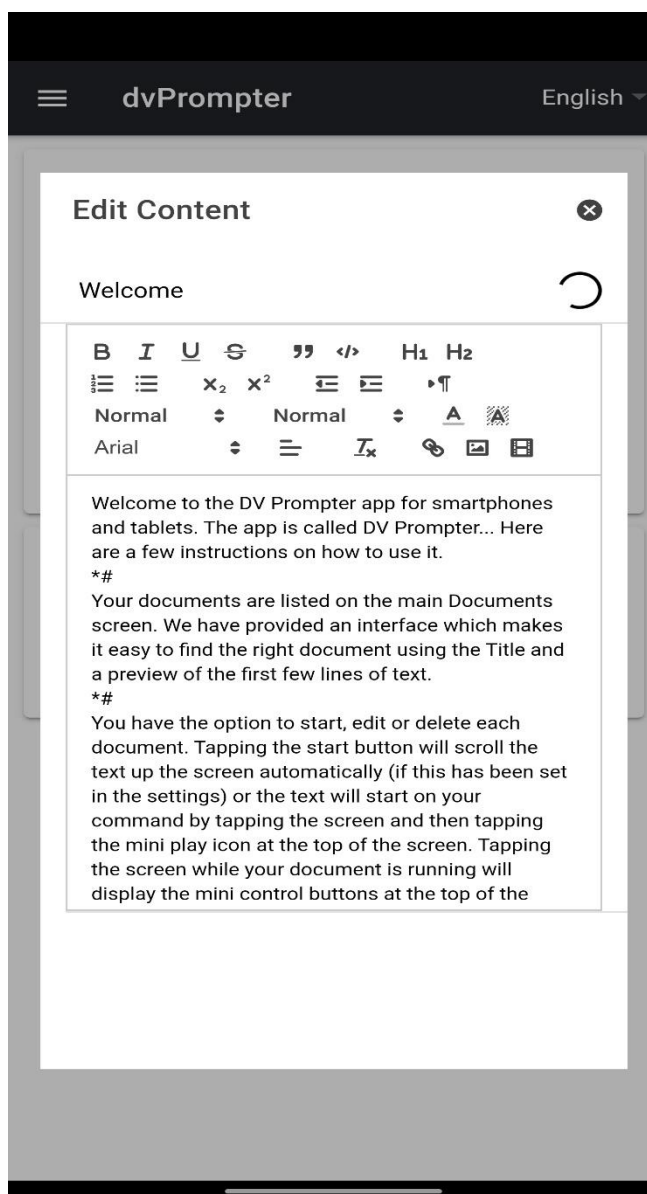

Via the web interface (Requires webui In-app purchase)

Please see the ‘Network’ section of this guide to understand how to access the remote control webui of the app.

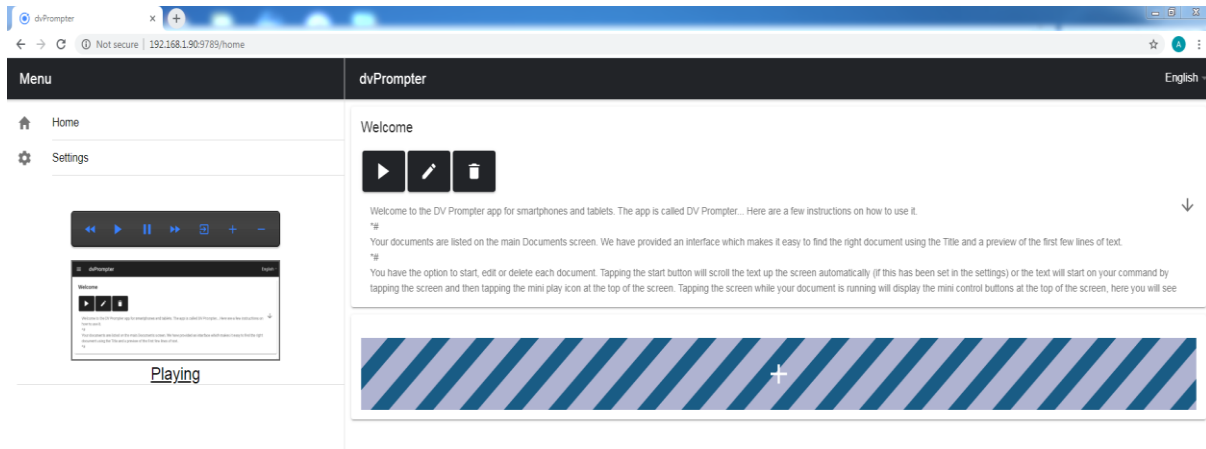

To create a new script on the device simply tap the ‘+’ button, enter a title and then enter the script body into the rich text editor. The script will be saved automatically when you close the rich text editor by taping the ‘X’.

To edit a script on the device simply tap the ‘Edit’ button, the script will be saved automatically when you close the rich text editor by taping the ‘X’.

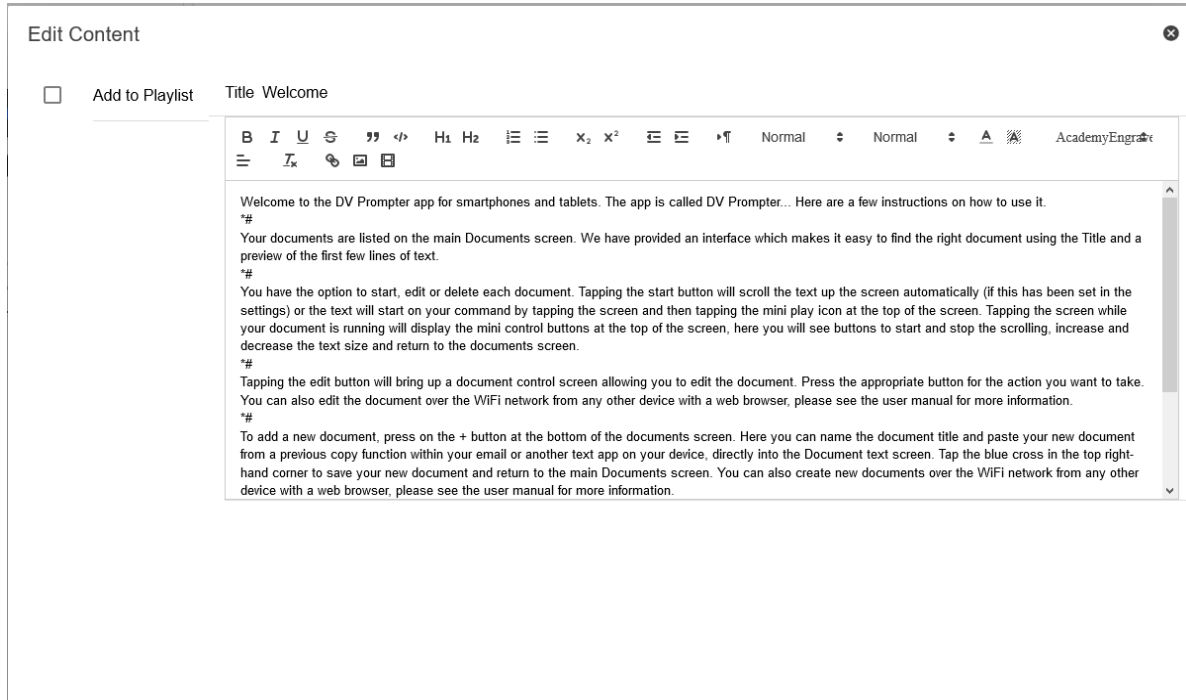

Playlists (Requires webui In-app purchase)

Adding a script to the playlist

Checking the 'In Playlist' option when creating or editing a script via the webui will allow the app to automatically load the next script in the list, it also allows you to quickly jump between scripts using the hardware remote control (see the control section of this guide for more information).

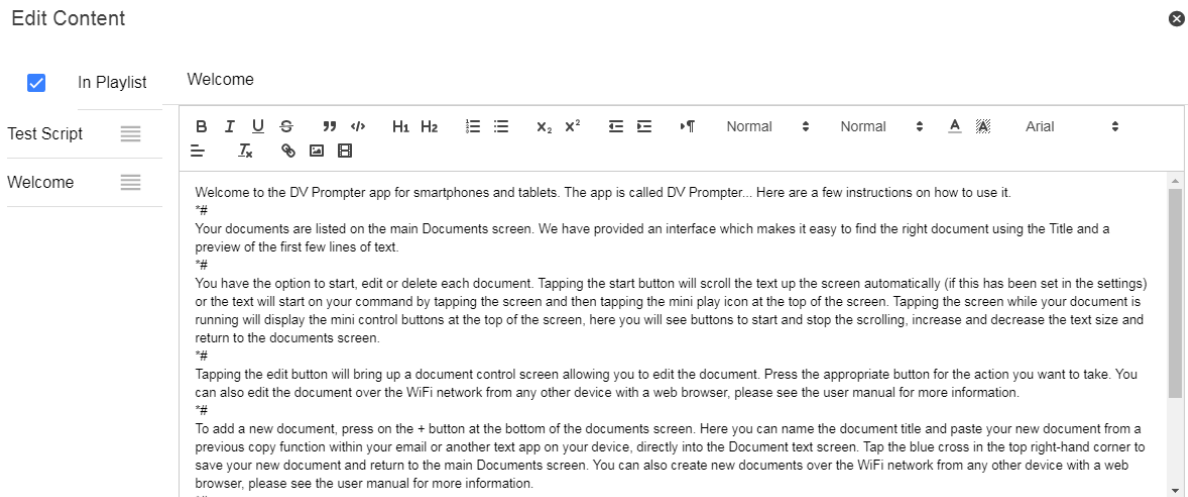

Changing the playlist order

To change the running order of the playlist simply click the horizontal bars to the right of the script name and drag to the desired position.

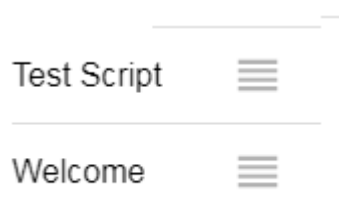

Control**Via the device (on screen)**

Tapping the screen when a scrip is loaded will display the menu bar shown below.

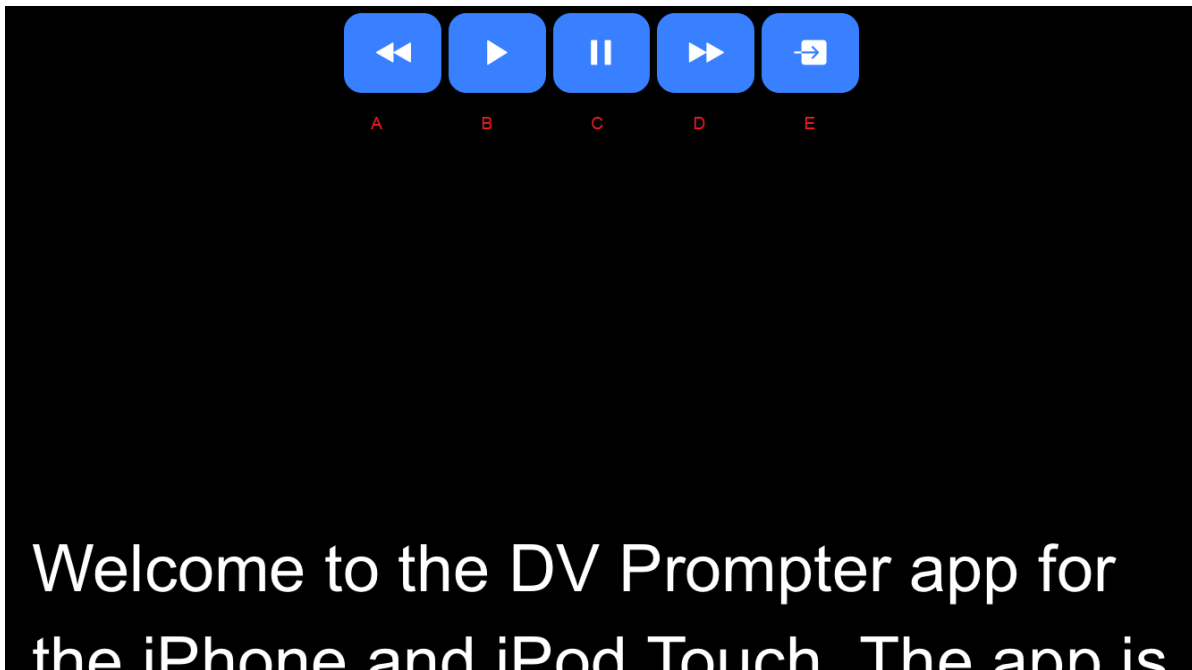

A: Decrease text size when scrolling / jump to previous script in playlist when paused

B: Start / Pause scrolling

C: Start / Pause scrolling

D: Increase text size when scrolling / jump to next script in playlist when paused

E: Unload script and return to documents screen

Via the web interface (Requires webui In-app purchase)

Please see the 'Network' section of this guide to understand how to access the remote control webui of the app.

The network control interface is shown below.

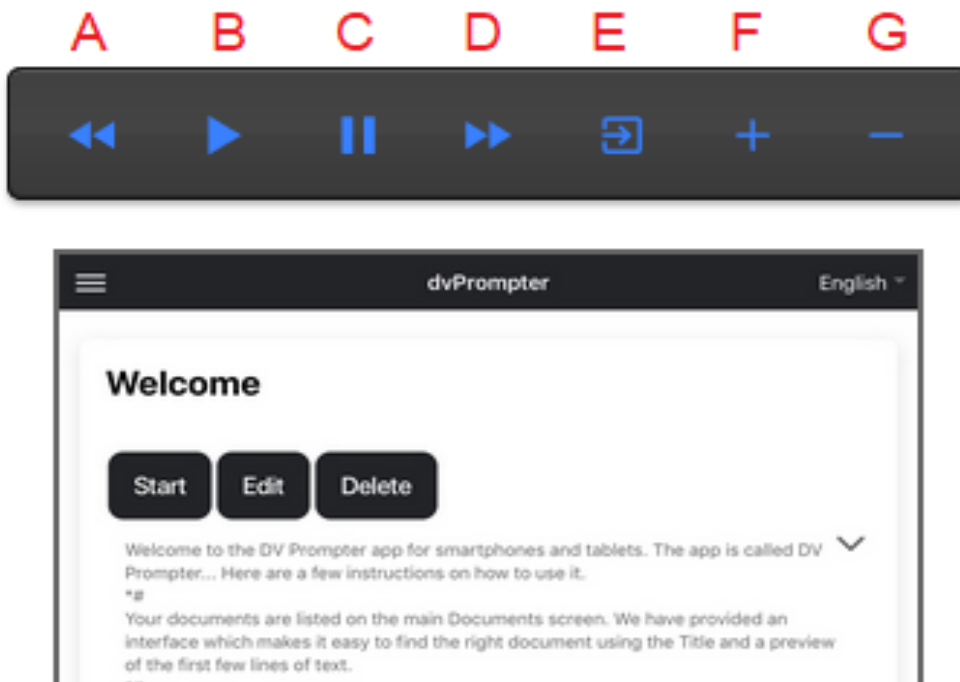

A: Decrease text size when scrolling / jump to previous script in playlist when paused

B: Start / Pause scrolling

C: Start / Pause scrolling

D: Increase text size when scrolling / jump to next script in playlist when paused

E: Unload script and return to documents screen

F: Increase speed when scrolling / jump to previous break marker when paused

G: Decrease speed when scrolling / jump to next break marker when paused

Using the WR-500

Wired mode

When first removed from the retail package the WR-500 remote is already in wired mode. When a button is pressed a RED LED will flash. The WR-500 can be switched to Bluetooth mode if required. In wired mode, the remote needs to be physically cabled to the tablet it is controlling. A four-pole jack to jack plug cable is provided with this remote. One end of the cable fits into the tablet's headset socket. The other end plugs into the jack socket on the WR-500 remote.





NOTE: When using this remote in wired mode the DV Prompter Plus app should also be set to Wired – WR-500 in the Remote Control menu option

Bluetooth mode

Switch the Bluetooth function ON within the device settings. Open the DV Prompter Plus app on the same tablet device and choose Bluetooth – WR-500 in the Remote Control menu. Select and start the required script within the DV Prompter Plus app. To switch the remote into Bluetooth pairing mode press and hold the centre Play / Pause button for 3 to 4 seconds. The GREEN LED will now blink on off repeatedly to indicate it is ready to pair with a Bluetooth device.

Once paired a Bluetooth icon will be shown on the main documents screen.

Note: The remote will sleep after 5 minutes of inactivity to save battery life. Press the play/pause button to wake the remote and it will automatically try to re-pair with the tablet previously used.

Button	Whilst scrolling text	Whilst text paused
	Speed up text scroll	Next Break Marker
	Slow down text scroll	Previous Break Marker
	Pause text	Play text
	Reduce font size	Load previous script
	Increase font size	Load next script

Menu Bar

Tapping the menu bar (found in the top left-hand corner of the documents screen) will display the menu shown below, you will see three options:

Home – Return to the documents screen

Settings – Display all app settings

Network – Display the address required to access the app from any device with a web browser over the local Wi-Fi or Ethernet network (the device must be connected to Wi-Fi) or Ethernet.

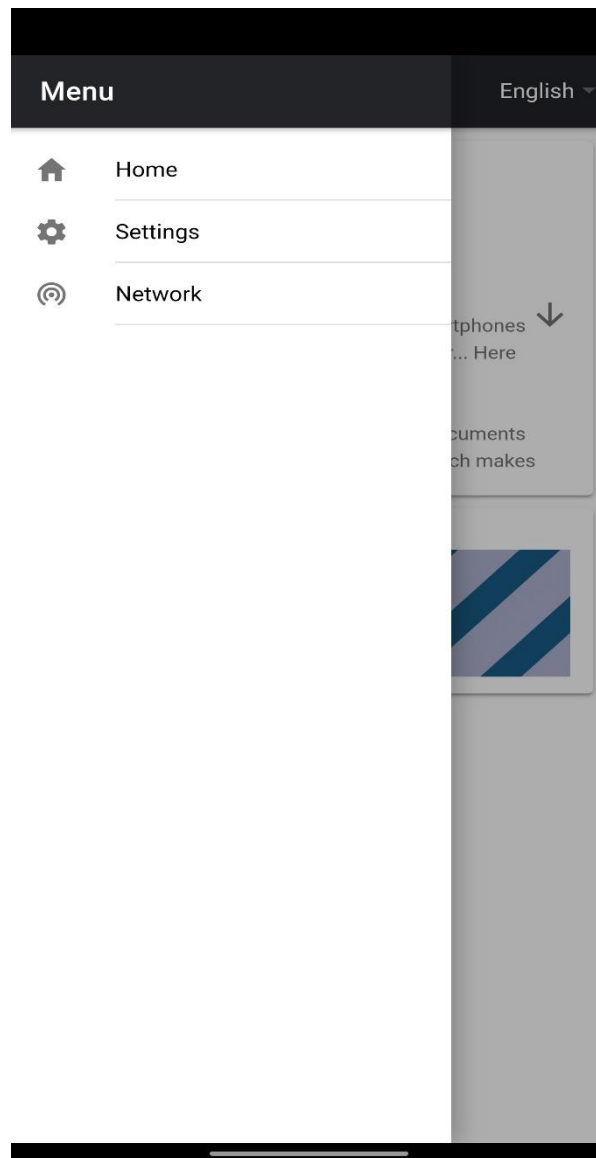

Settings

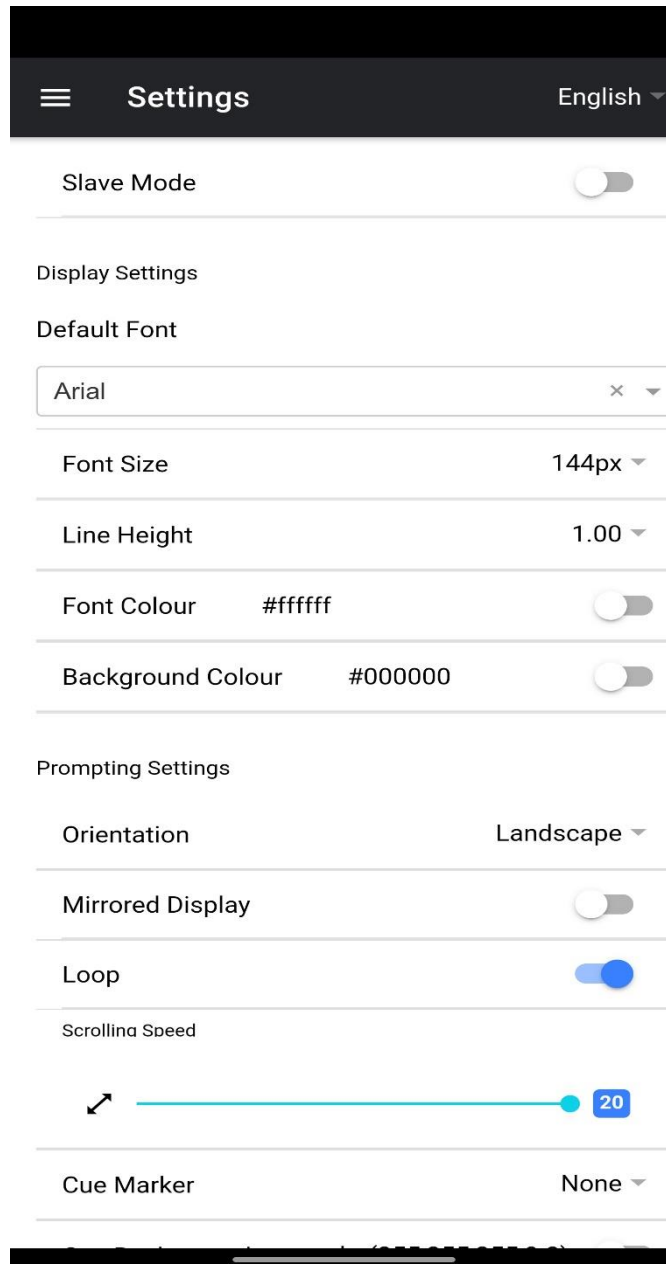

Settings English ▾

Slave Mode

Display Settings

Default Font

Arial × ▾

Font Size 144px ▾

Line Height 1.00 ▾

Font Colour #ffffff

Background Colour #000000

Prompting Settings

Orientation Landscape ▾

Mirrored Display

Loop

Scrolling Speed

↖ 20

Cue Marker None ▾

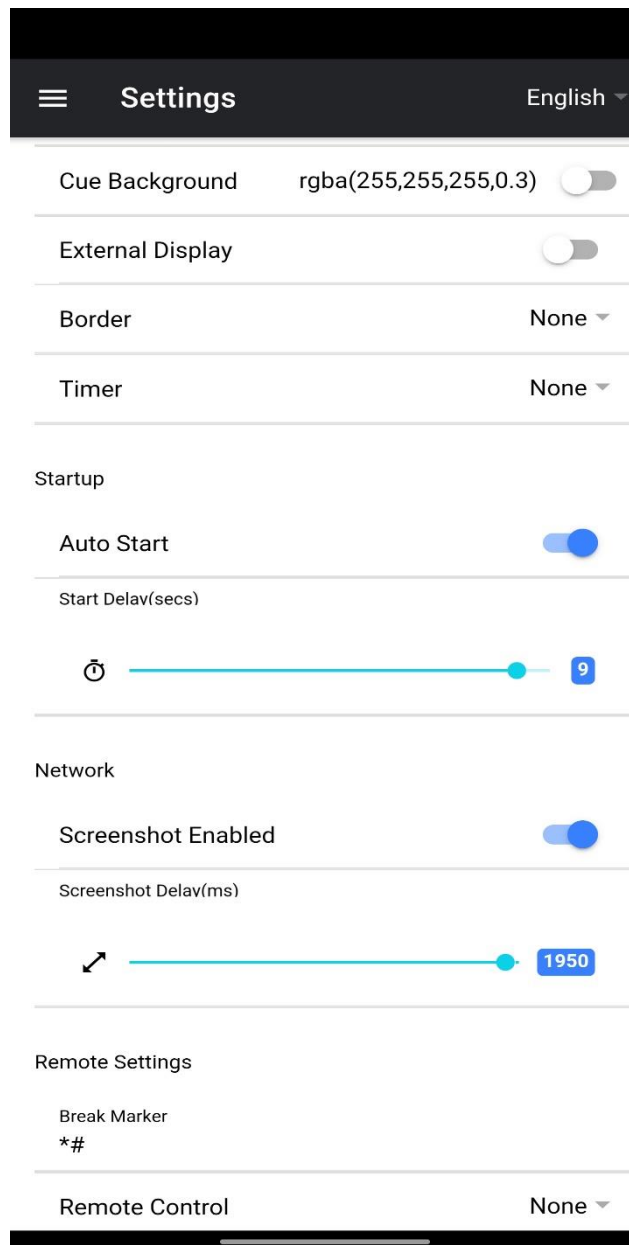

Slave Mode: When enabled the device will act as a slave screen to another dvPrompter app, please see the 'Synchronising multiple devices' section for more information.

Default font: Select the default font used by the editor (this can be overridden on a per script basis using the editor).

Font Size: Sets the default font size, this will apply to all text that does not have a font size set within the editor.

Line Height: Sets the spacing between lines when scrolling, values below 1 may result in text overlapping.

Font colour: Sets the default font colour (this can be overridden on a per script basis using the editor).

Background colour: Sets the background colour.

Orientation: Select if your device will be 'Landscape' or 'Portrait'.

Mirrored Display: Set to 'Off' if reading the text directly from the device, set to 'On' if reading the text via a mirror.

Loop: Set to 'On' to continually loop the script when finished (only valid when playlists are not in use).

Scrolling speed: Set the speed the text will start to scroll at, this can be adjusted via the hardware or network remote control.

Cue marker: Optionally select a cue marker to define the line of text the talent should read.

Cue Background: Set the cue marker background colour (only valid when using plain or combined cue markers).

External Display: When disabled any second display connected via HDMI or wireless will mirror the main display, when enabled text will only scroll on the second display, the main display can be used to create and edit scripts as well as control the text.

Border: Used to add a border around the scrolling text, this is useful if the text is too close to the edge of your monitor and or beam-splitter glass.

Timer: Display a timer showing the time the text as been scrolling on screen, the timer will reset when a new script is loaded and pause when the script is paused.

Auto start: When set to 'On' the script will start scrolling automatically, when set to 'Off' the script must be started using the on-screen menu, hardware or network remote control.

Start delay: Optionally set a delay (in seconds) between the start command being issued and text starting to scroll (work with manual start and auto start).

Screenshot Enabled: Enables or disabled the screenshots used for remote monitoring via the web interface.

Screenshot Delay (ms): The time in milliseconds a screenshot is taken and send to the network web interface for remote monitoring, a lower value will result in less delay but higher CPU and network usage. Lower values will require faster hardware.

Break marker: You can also set up text characters like *# that indicate a break in the scrolled text called break markers. These markers can then be used to quickly jump forward or backward between points in the text, when using the hardware or network remote control, should the running order of the production change.

Remote control: The optional Datavideo WR-500 controller can be used to control the script, please select either Bluetooth or wired mode.

Webui Access: Purchase webui access to unlock the following features:

- Create, edit and manage an unlimited number of scripts over a local network
- Control the prompter over a local network using any device with a HTML5 compatible web browser
- Real time script editing (edit scripts that are in use)
- Playlist support
- Load, reload and control scripts over a local network
- Master/slave mode allows you to use a second device as a slave screen over a WiFi or Ethernet network

Network (Requires webui In-app purchase)

If your device is connected to a Wi-Fi or Ethernet network you can fully control the app over the network, simply enter the webui address into the web browser of another device on the same network.

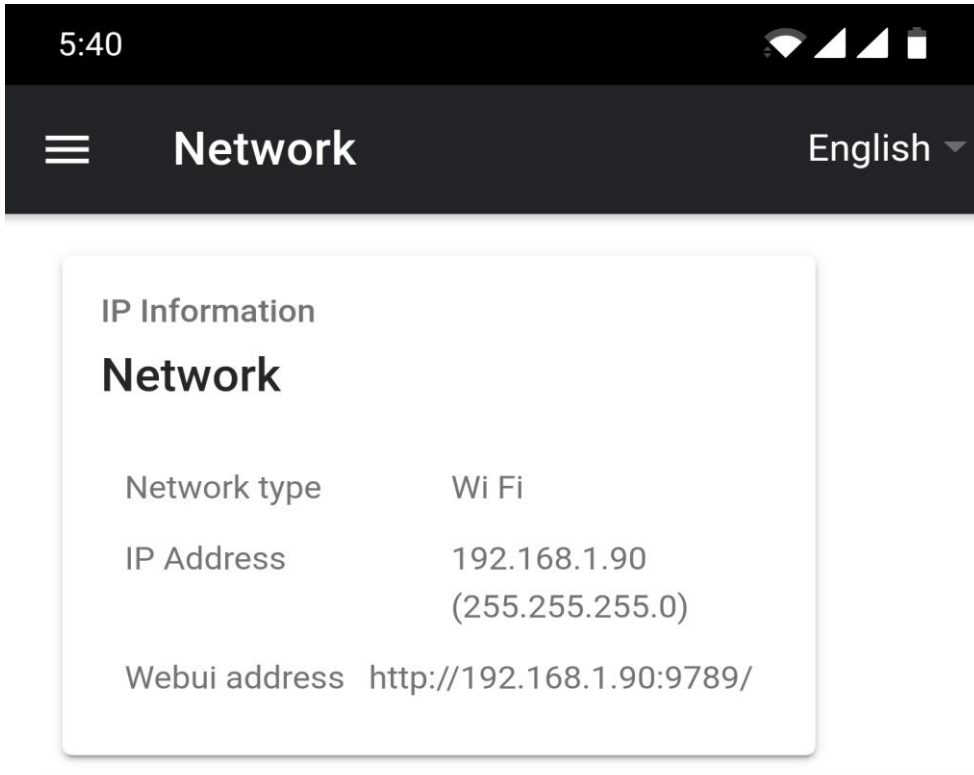

You can see an example of the remote-control interface below.

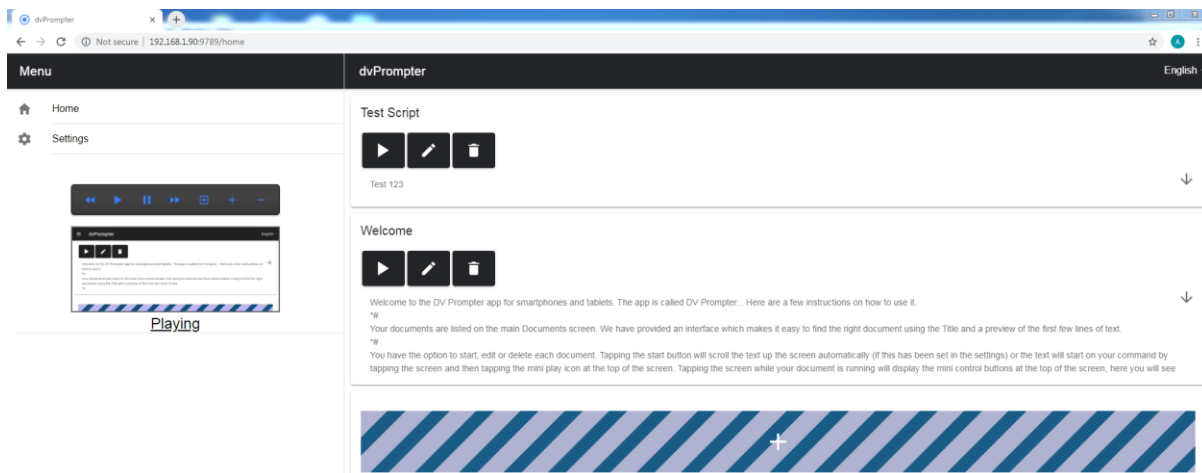

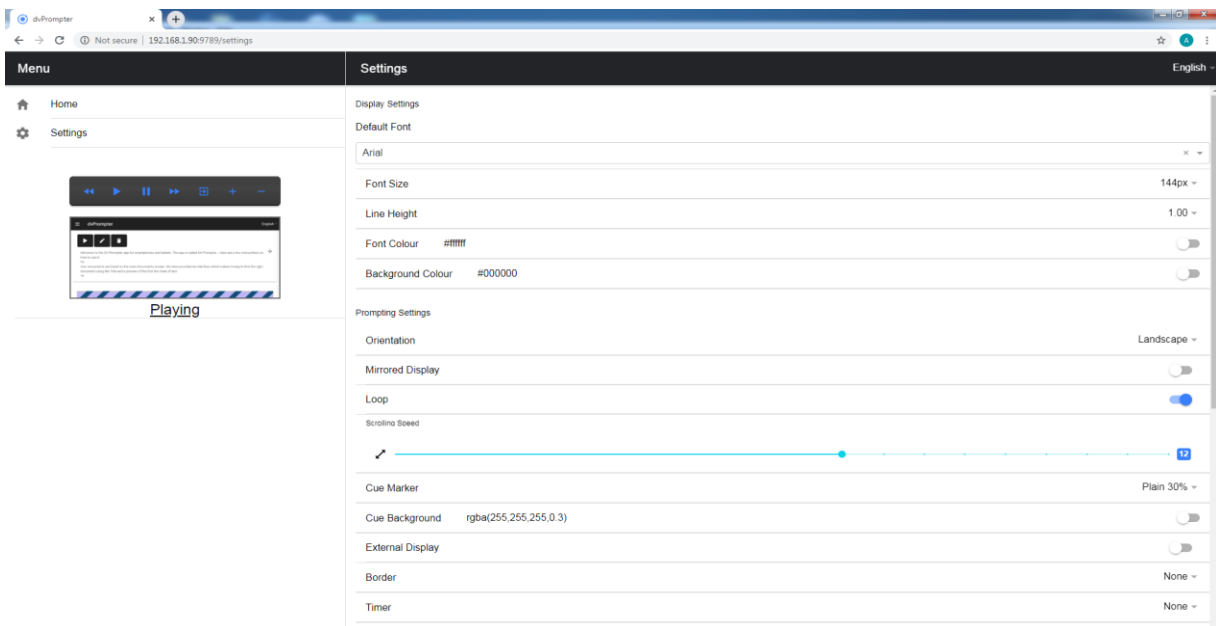
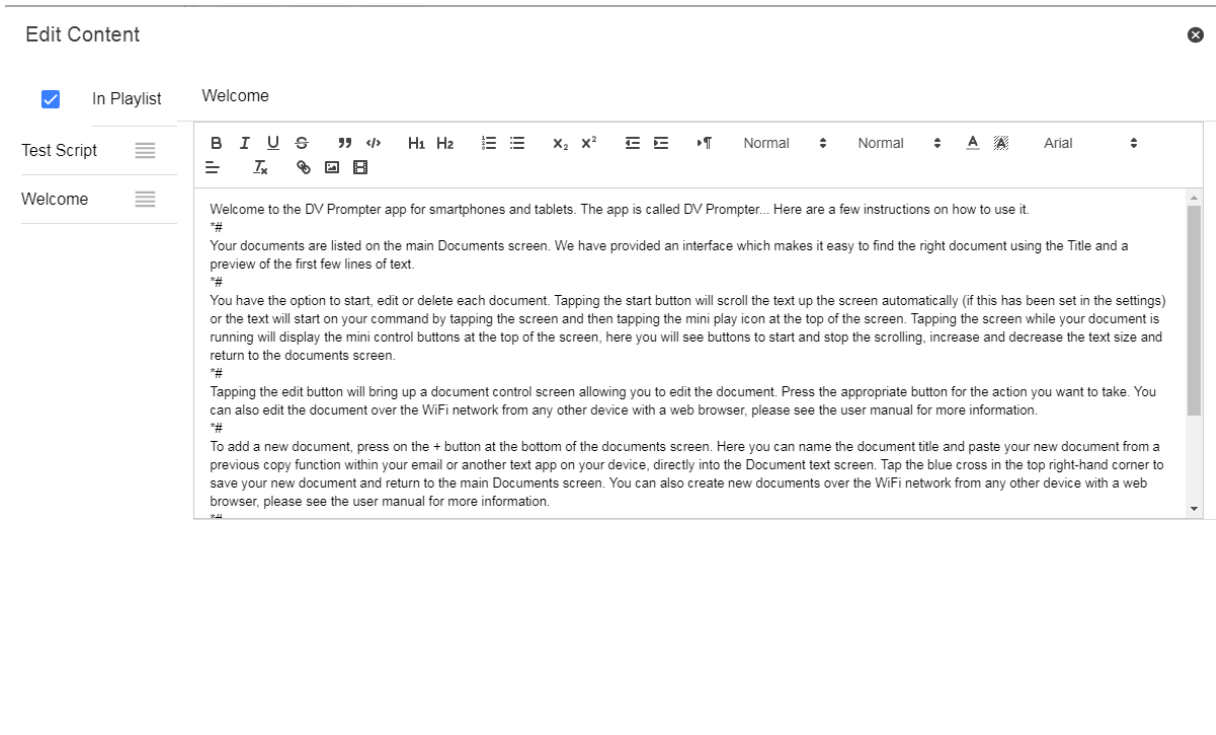

Synchronizing Multiple Device (Requires webui In-app purchase)

The feature allows you to synchronise the scrolling text on two or more devices via a WiFi or Ethernet network.

Requirements

- The master device must have the webui unlocked via the in-app purchase.
- All devices must be identical in order for synchronisation to work (devices with identical screen heights may work but this cannot be guaranteed).
- Slave devices will place additional load on the master device, the number of slave devices that can be connected is dependant on the performance of the master device.
- All slave devices must be connected to the same local network as the master device.

Setup Instructions

1. Obtain the IP address of the master device by navigating to the network menu.

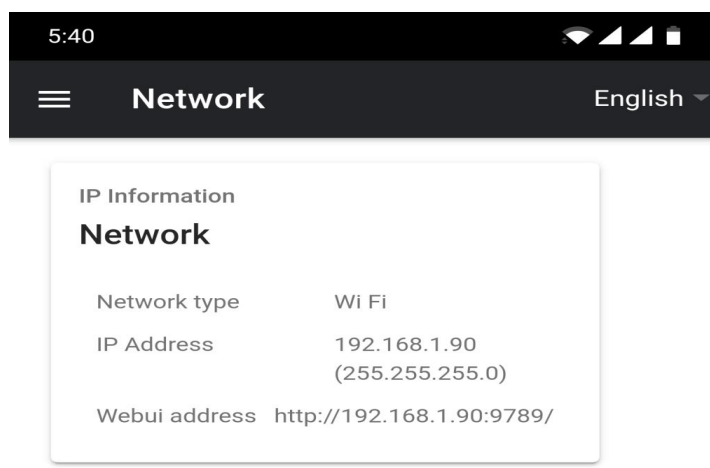

2. Open the settings menu on the slave device, enable slave mode and enter the IP address of the master.

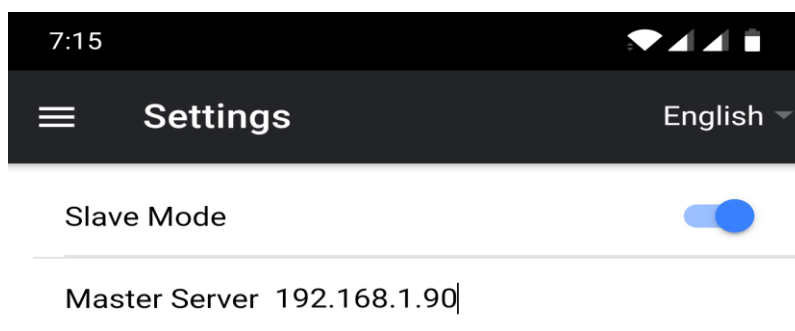

3. Tap home on the menu bar, you will see the screen below while the slave establishes a connection to the master.



Waiting for master***

4. Once connected the screen will turn white then black, the slave will now mirror the master.
5. To exit slave mode tap the screen then press the blue exit button, the app will close.

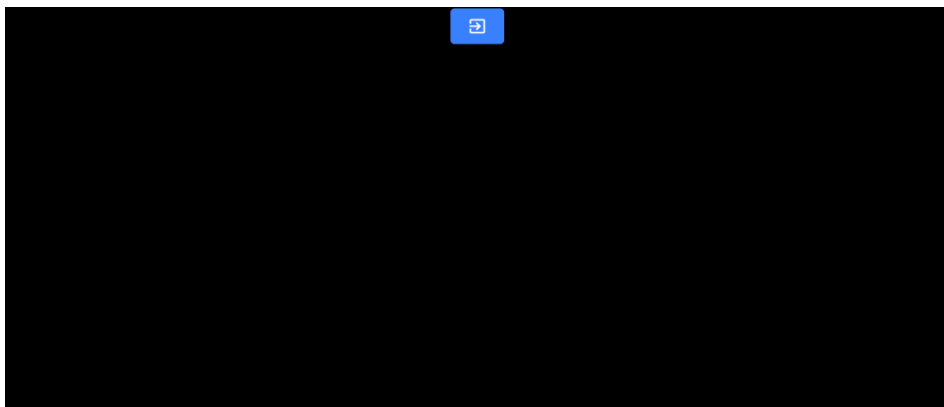

Connecting an External Display

You can connect an external display using HDMI (via an appropriate HDMI adapter for your device) or using wireless screen mirroring such as Airplay and Mirror-cast.

External Display Setting Disabled

In this mode the external display will mirror the devices screen.

External Display Setting Enabled

In this mode the text will only scroll on the external display leaving the device screen free for script control and editing. The script control options can be access via the menu bar as seen below.

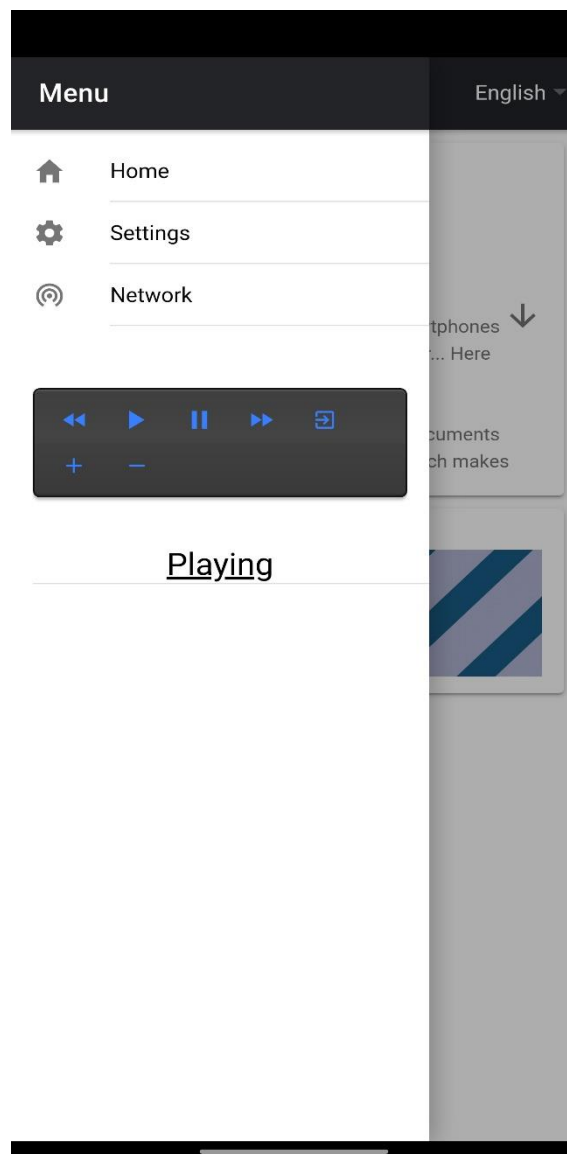

Optional HC-500 Hard Case

The foam packaging of the TP-500 kit has been designed so that customers who buy the optional hard case can simply lift the foam out from the retail carton and insert it directly into the optional HC-500 hard case.



As standard, the HC-500 hard case is supplied with the usual diced, pick & pluck foam so these cases can also be used as optional carrying cases for a variety of equipment – not just the TP-500 kit.

HC-500 Features

- Press & pull latches
- Secure impact resistant hinges with integrated feet
- Case can stand upright and level on hinge spine
- Solid core handle is both comfortable and durable
- Shock proof, vibration proof, dust proof and rust proof
- Low temperature (-25C / -13F) resistance tested
- Sealable for moisture protection
- Pressure release valve
- Stackable

Please speak with your supplier or dealer if you wish to purchase an optional HC-500 hard case.

HC-500 specifications

Dimensions : External	H 275mm x W 330mm x D 120mm
Dimensions : Internal base	H 215mm x W 295mm x D 75mm without foam
Dimensions : Internal lid	H 215mm x W 295mm x D 20mm without foam
Weight :	1.68 Kg (3.70 lbs) with pick and pluck foam only
Weight :	3.06 Kg (6.75 lbs) Including TP-500 kit and foam

Frequently Asked Questions

Q: My Bluetooth remote (WR-500) does not pair with my cell phone or tablet. Is there something I am doing wrong?

Is the remote fully charged? If yes, try resetting the Bluetooth remote next. Then try pairing the device and remote again. Still not working? Clear, or delete, any items already in the tablet or cell phone's Bluetooth list. On Apple iOS devices there is an arrow right icon next to each Bluetooth item previously connected. Tap on the arrow then use the remove or forget option. Android devices act in almost the same way with a settings icon instead. On Android devices the option may be unpair or delete. Once all previous Bluetooth items have been removed from the list then try pairing the device with the Bluetooth remote again. Try the above steps before contacting your supplier.

Q: My remote (WR-500) has paired with my tablet device over Bluetooth but I still have no control when using the DV Prompter Plus App. Is there something I am doing wrong?

Check you are using the latest version of the DV Prompter Plus App. If in doubt delete the App from the device, then download it again from the App store or Google Play. The **DV Prompter Plus App Settings** are important too. The **Remote setting should be changed to Bluetooth** before attempting to control the script scrolling etc. Try the above steps before contacting your supplier.

Specifications

Prompter Size

Width: 270 mm (10.62 inches)

Height: 210 mm (8.27 inches)

Depth: 460 mm (18.11 inches)

Expandable Mounting Bracket

Sizes: 110 mm (Minimum tablet width)

210 mm (Maximum tablet width)

Nett Weight:

Kit: 1.5 Kg (3.3 lbs)

Packed weight: (Gross)

Kit: 1.75 Kg (3.84 lbs)

NOTES

NOTES

Service & Support

It is our goal to make owning and using Datavideo products a satisfying experience. Our support staff is available to assist you to set up and operate your system. Contact your local office for specific support requests. Plus, please visit www.datavideo.com to access our FAQ section.



Please visit our website for latest manual update.

www.datavideo.com/product/TP-500

datavideo
www.datavideo.com



@DatavideoUSA @DatavideoIndia2016
@DatavideoEMEA @Datavideojapan
@DatavideoTaiwan @DatavideoLatam
@DatavideoAsia @DatavideoBrasil



@Datavideo
@Datavideo_EMEA
@Datavideo_Taiwan



@DatavideoUSA
@DVTWDCN



@DatavideoUSA
@DatavideoEurope

All the trademarks are the properties of their respective owners.
Datavideo Technologies Co., Ltd. All rights reserved 2020

Feb-22.2021
Version E12