

ZOOM®

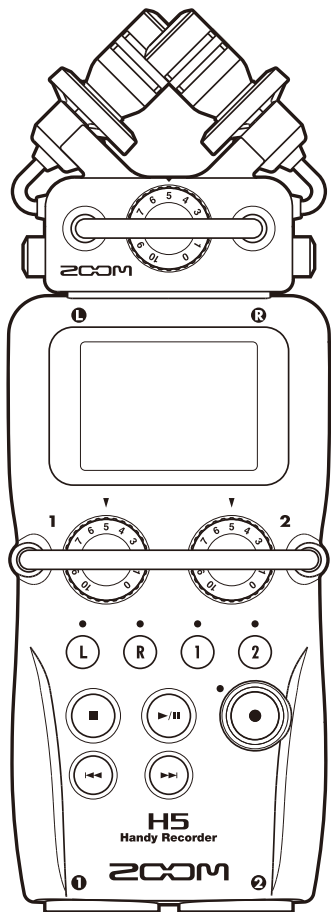

H5 Handy Recorder

Operation Manual

© 2014 ZOOM CORPORATION

Reproduction or reprinting of this manual in whole or in part by any means without permission is prohibited.

Safety and usage precautions

SAFETY PRECAUTIONS

In this operation manual, symbols are used to highlight warnings and cautions that you must read to prevent accidents. The meanings of these symbols are as follows.

 Something that could cause serious injury or death

 Something that could cause injury or damage to the equipment

Other symbols used

 An action that is mandatory

 An action that is prohibited

Warnings

Operation using an AC adapter

- ❗ Use only a ZOOM AD-17 AC adapter with this unit.
- ⊘ Do not do anything that could exceed the ratings of outlets and other electrical wiring equipment. Do not use with power other than AC 100V.

Before using the equipment in a foreign country or other region with a power voltage other than AC100V, always consult with a shop that carries ZOOM products and use the appropriate AC adapter.

Operation using batteries

- ❗ Use 2 ordinary 1.5-volt AA batteries (alkaline or nickel-metal hydride).
- ❗ Read battery warning labels carefully.
- ❗ Always close the battery compartment cover when using the unit.

Alterations

- ⊘ Do not open the case or modify the product.

Precautions

Product handling

- ❗ Do not drop, bump or apply excessive force to the unit.
- ❗ Be careful not to allow foreign objects or liquids to enter the unit.

Operating environment

- ⊘ Do not use in extremely high or low temperatures.
- ⊘ Do not use near heaters, stoves and other heat sources.
- ⊘ Do not use in very high humidity or where it could be splashed by water.
- ⊘ Do not use in places with frequent vibrations.
- ⊘ Do not use in places with much dust or sand.

AC adapter handling

- ❗ When disconnecting the power plug from an outlet, always hold the plug when pulling.
- ❗ Disconnect the power plug from the outlet during lightning storms and when not using the unit for a long time.

Battery handling

- ❗ Install the batteries with the correct +/- orientation.
- ❗ Use a specified battery type. Do not mix new and old batteries or different brands or types at the same time.
- ❗ When not using the unit for an extended period of time, remove the batteries.
- ❗ If a battery leak should occur, wipe the battery compartment and the battery terminals carefully to remove all residue.

Mics

- ❗ Before connecting a mic, always turn the power off. Do not use excessive force when connecting it.

Connection cables and input/output jacks

- ❗ Always turn the power OFF for all equipment before connecting any cables.
- ❗ Always disconnect all connection cables and the AC adapter before moving the unit.

Volume

- ⊘ Do not use at a loud volume for a long time.

Usage Precautions

Interference with other electrical equipment

In consideration of safety, the **HS** has been designed to minimize its emission of electromagnetic waves and to suppress interference from external electromagnetic waves. However, equipment that is very susceptible to interference or that emits powerful electromagnetic waves could result in interference if placed nearby. If this occurs, place the **HS** and the other device farther apart.

With any type of electronic device that uses digital control, including the **HS**, electromagnetic interference could cause malfunction, corrupt or destroy data and result in other unexpected trouble. Always use caution.

Cleaning

Use a soft cloth to clean the exterior of the unit if it becomes dirty. If necessary, use a damp cloth that has been wrung out well. Never use abrasive cleansers, wax or solvents such as alcohol, benzene or paint thinner.

Breakdown and malfunction

If the unit becomes broken or malfunctions, immediately disconnect the AC adapter, turn the power OFF and disconnect other cables. Contact the store where you bought the unit or ZOOM service with the following information: product model, serial number

and the specific breakdown or malfunction symptoms, along with your name, address and telephone number.

Copyrights

- © Windows®, Windows® 8, Windows® 7 and Windows Vista® are trademarks or registered trademarks of Microsoft Corporation.
- © Macintosh, Mac OS and iPad are trademarks or registered trademarks of Apple Inc.
- © The SD and SDHC logos are trademarks.
- © The use of MPEG Layer-3 audio compression technology is licensed from Fraunhofer IIS and Sivel SpA.
- © All other product names, trademarks and company names in this document are the property of their respective owners.

Note: All trademarks and registered trademarks in this document are for identification purposes only and are not intended to infringe on the copyrights of their respective owners.

Recording for any purpose other than personal use from copyrighted sources, including CDs, records, tapes, live performances, video works and broadcasts, without permission of the copyright holder is prohibited by law. Zoom Corporation will not assume any responsibility related to infringements of copyrights.

Introduction

Thank you very much for purchasing a ZOOM **H5** Handy Recorder. The **H5** has the following features.

● Stereo mics can be changed according to use

An XY mic that can record sound images with depth is included. You can switch mics according to the situation as you would switch lenses on an SLR camera.

● Record up to 4 tracks at once

In addition to the swappable stereo mic (L/R inputs), the main unit has 2 XLR/TRS inputs (Inputs 1/2). Use these to simultaneously record a maximum of 4 tracks, including ambiance, narration, an overall sound image and the voices of multiple performers, for example.

● Advanced recording features

- The XY mic uses a shock mount structure to minimize external vibration noise. In addition, it can handle sound pressure input of up to 140 dBSPL, allowing it to capture sounds that previous recorders could not handle. With this capability, it can make stereo recordings with excellent separation.
- Using the L/R inputs, you can simultaneously record a backup file with a recording level that is 12 dB less than the regular recording. You can use this backup recording if an unexpected loud noise should cause the regular recording to distort, for example.
- All input volume (gain) levels can be adjusted quickly by hand using dedicated knobs.

● Useful operation features

- SDHC cards (up to 32GB) can be used as recording media.
- In addition to the standard headphones output, a line output jack is built-in. This allows you to send the audio signal to a video camera or other device while monitoring with headphones.
- When connected by USB, in addition to use as a card reader or conventional 2 IN/2 OUT audio interface, it can also be used as a 4 IN/2 OUT interface (driver required for Windows).
- Of course, a tuner, a metronome and playback speed and pitch adjustment functions are included among the useful features shared with other H series recorders. A remote control (wired) is also available.

Please read this manual carefully to fully understand the functions of the **H5** so that you can make the most of it for many years. After reading this manual, please keep it with the warranty in a safe place.

Contents

Safety and usage precautions.....	02	Pre-recording.....	29	Adjusting the input signal monitoring mix.....	82
Introduction.....	03	Counting in before recording.....	30	Lowering the line output level.....	84
Contents.....	04	Adjusting the side mic level.....	31	Monitoring MS-RAW signals.....	85
Names of parts.....	05	Backup recording.....	32	Converting input MS signals to stereo.....	86
Mic overview.....	07	Overdubbing.....	33	Mixing input signals to mono.....	88
XY mic.....	07	Playback	38	Setting the recording format.....	89
Connecting mics.....	07	Basic playback.....	38	Changing automatic recording settings.....	90
Disconnecting mics.....	07	Selecting playback project/files from lists.....	40	Setting the automatic recording start level.....	90
Connecting mics/other devices to Inputs 1/2.....	08	Changing the playback mode.....	41	Setting automatic stopping.....	91
Connecting mics.....	08	Changing the playback pitch (key).....	42	Setting how projects/files are named.....	92
Connecting instruments and other devices.....	08	Changing the playback speed.....	44	Other settings	93
Connection examples.....	09	Repeat playback of a set interval (AB repeat).....	46	Reducing noise (low cut filter).....	93
Display overview.....	10	Mixing projects.....	48	Adjusting the input level (compressor/limiter).....	94
Home/Recording Screen.....	10	Checking/editing projects/files	50	Changing the phantom power setting.....	96
Playback Screen.....	11	Checking project/file information.....	50	Using plug-in power.....	97
Preparations	12	Checking track marks.....	51	Reducing the input signal level.....	98
Supplying power.....	12	Changing project/file names.....	52	Setting the counter.....	99
Using batteries.....	12	Mixing down a project.....	54	Set how time is shown during recording.....	99
Using an AC adapter.....	12	Converting WAV files to MP3 files.....	56	Set how time is shown during playback.....	100
Loading an SD card.....	13	Normalizing.....	58	Changing the display backlight setting.....	101
Turning the power on and off.....	14	Dividing projects/files.....	60	Adjusting the display contrast.....	102
Turning the power on.....	14	Trimming project beginnings and ends.....	62	Checking the firmware versions.....	103
Turning the power off.....	14	Deleting multiple files.....	64	Restoring the default settings.....	104
Using the hold function.....	15	Deleting multiple projects.....	66	Checking SD card open space.....	105
Setting the date and time.....	16	Rebuilding a project.....	67	Formatting SD cards.....	106
Setting the type of battery used.....	17	Adding voice memos.....	68	Testing SD card performance.....	107
Recording	18	USB functions	70	Conducting a quick test.....	107
Recording process.....	18	Data exchange with computers (card reader).....	70	Conducting a full test.....	108
Recording mode overview.....	19	Using as an audio interface.....	72	Other functions	110
MULTI FILE mode.....	19	Audio interface settings.....	74	Updating the firmware.....	110
STEREO FILE mode.....	19	Making direct monitoring settings.....	74	Using SD cards from older H series recorders.....	111
Selecting the recording mode.....	20	Monitor signal mixing (MULTITRACK only).....	75	Using a remote control.....	112
Folder and file structure on the H5.....	21	Using Loop Back (STEREO only).....	77	Appendices	113
Selecting inputs and adjusting levels.....	22	Tools	78	Troubleshooting.....	113
Recording.....	24	Using the tuner.....	78	Specifications.....	114
Setting where projects/files are saved.....	26	Using the metronome.....	80		
Recording automatically.....	27				

Names of parts

Left

Front

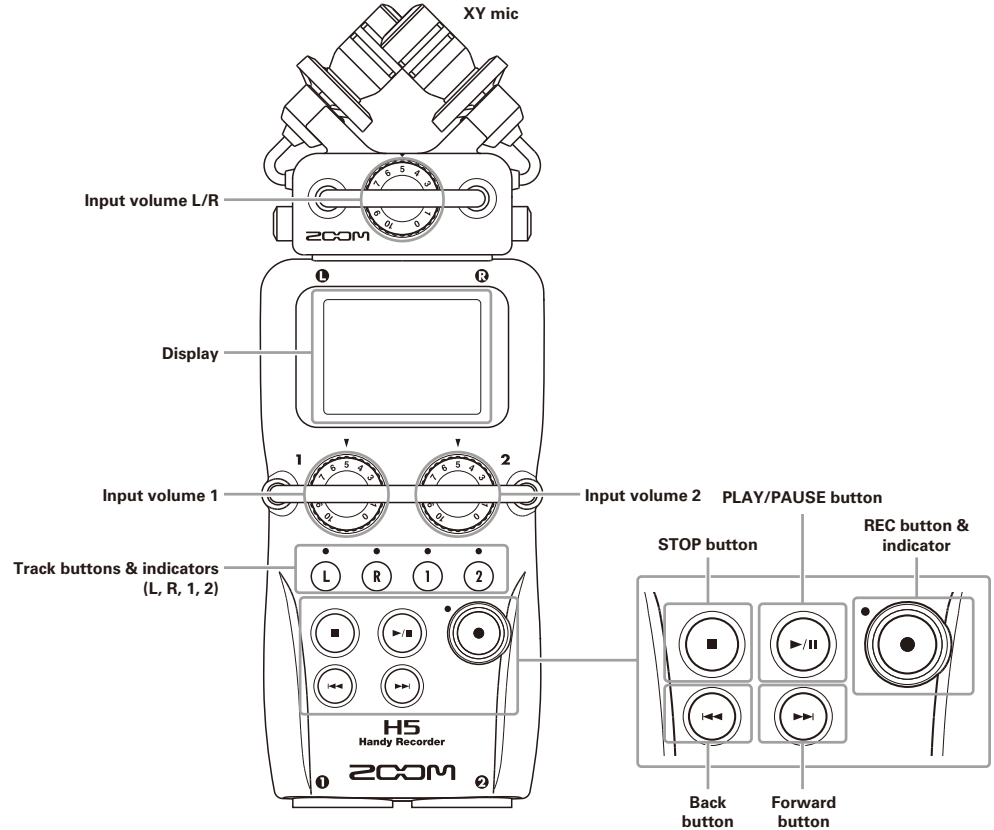
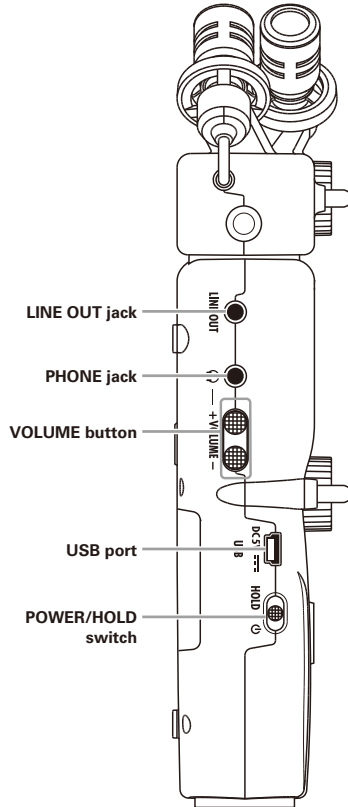

Names of parts (continued)

Right/Back

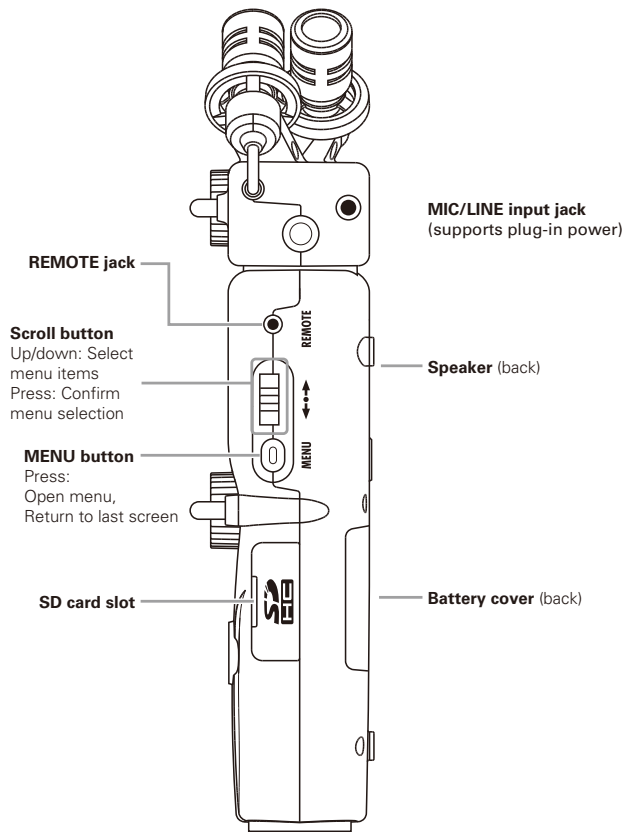

Bottom

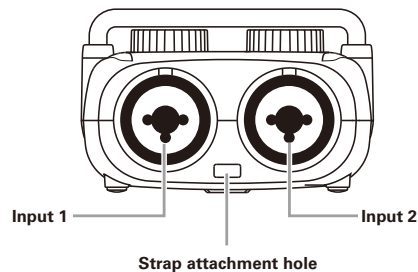

XLR

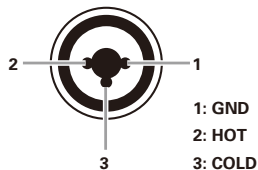

TRS

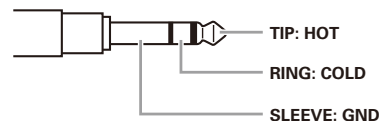

Mic overview

The XY mic included with the **H5** can be swapped according to your need with another input capsule.

XY mic

This has two crossing directional mics.

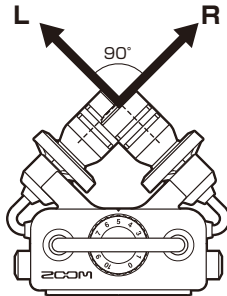

Features

- Shock mount structure minimizes external vibration noise.
- Mic can handle sound pressure input of up to 140 dB SPL, allowing it to capture sounds that previous recorders could not.
- Three-dimensional sound with natural depth and width.

NOTE

The XY mic has a MIC/LINE input jack that can be used to connect an external mic or line-level device. This jack can also provide plug-in power to mics that use it. (→P. 97)

Connecting mics

While pressing the buttons on the sides of the mic, connect it to the main unit, inserting it completely.

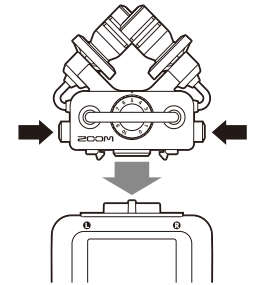

Disconnecting mics

While pressing the buttons on the sides of the mic, pull it out of the main unit.

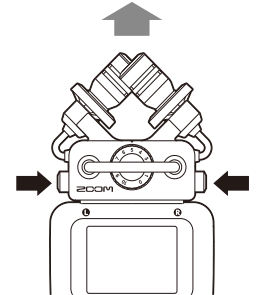

NOTE

- When disconnecting a mic, do not use too much force. Doing so could damage the mic or the main unit.
- Recording will stop if a mic is removed during recording.

Connecting mics/other devices to Inputs 1/2

In addition to the L/R inputs from the XY mic, the **HS** also has Inputs 1/2. These can be used together to record up to 4 tracks at the same time.

You can connect mics, instruments and other devices to Inputs 1/2.

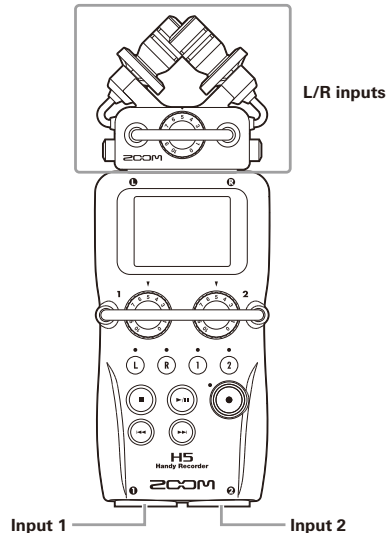

Connecting instruments and other devices

Connect keyboards and mixers directly to the Input 1/2 TRS jacks.

Direct input of passive guitars and basses is not supported. Connect these instruments through a mixer or effects device.

Turn the PAD function ON when connecting a mixer or other device with a standard output level of +4dB. (→ P. 98)

Connecting mics

Connect dynamic mics and condenser mics to the Input 1/2 XLR jacks.

Phantom power (+12V/+24V/+48V) can be supplied to condenser mics. (→ P. 96)

Connection examples

Recording is possible in a variety of situations, such as the following.

While filming

- L/R input mic: Main subject
- Shotgun/lapel mics connected to Inputs 1/2: Performer

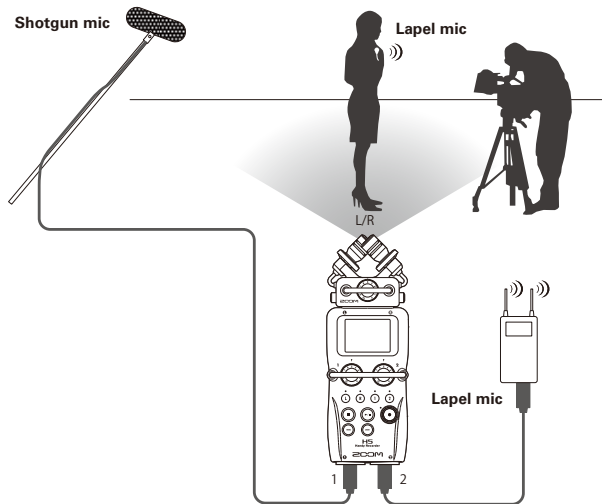

Concert recording

- L/R input mic: Performance on stage
- Inputs 1/2: Line outputs from mixer

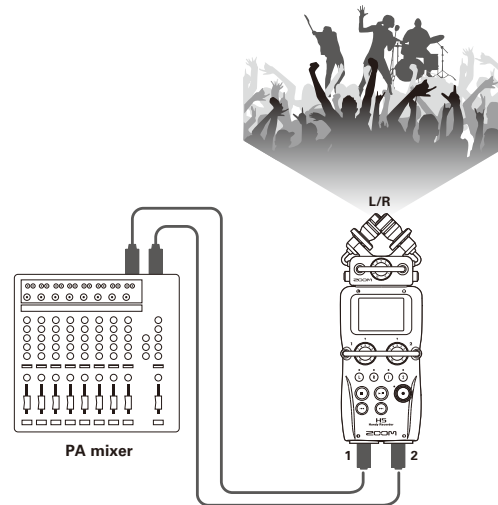

Display overview

Home/Recording Screen

MULTI FILE Mode

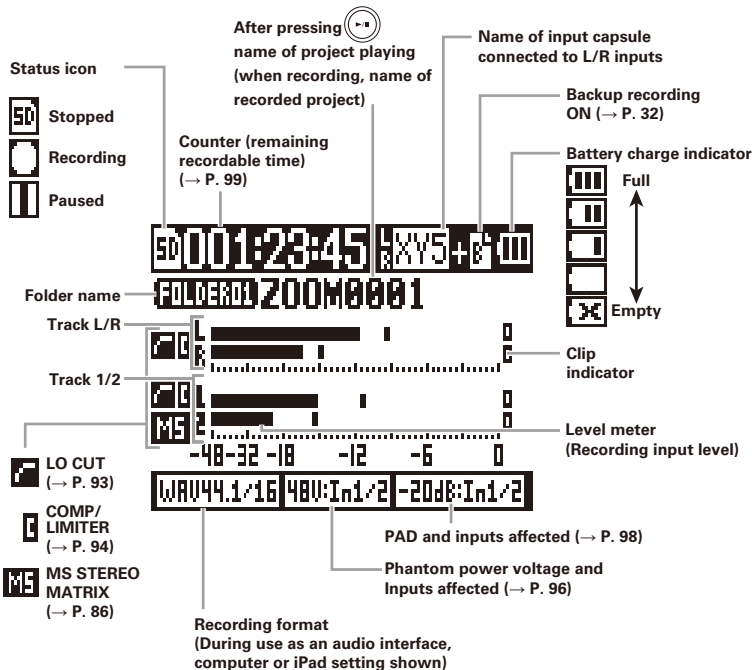

STEREO FILE Mode

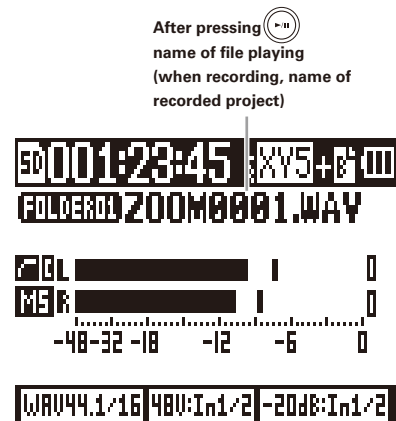

Playback Screen

MULTI FILE Mode

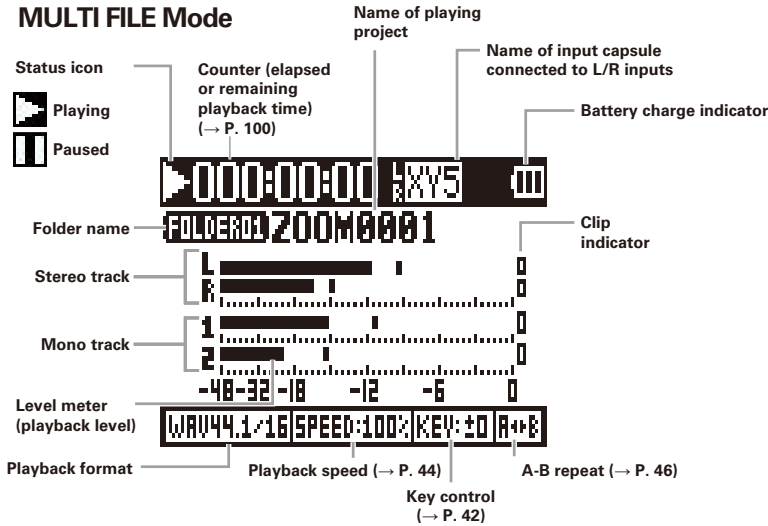

STEREO FILE Mode

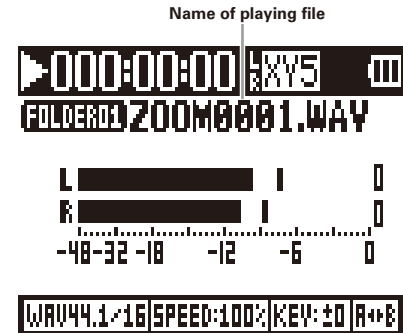

Supplying power

Using batteries

1. Turn the power off and then remove the battery cover.

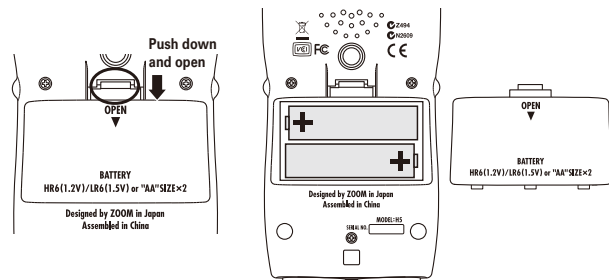

2. Install the batteries.

3. Replace the battery cover.

NOTE

- Use alkaline batteries or rechargeable NiMH batteries.
- If the battery indicator becomes empty, turn the power off immediately and install new batteries.
- Set the type of battery being used. (→ P. 17)



Using an AC adapter

1. Connect a USB cable to the USB port.
-
2. Plug the adapter into an outlet.

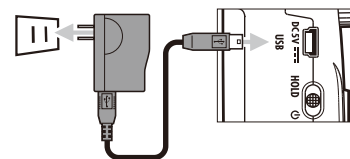

Loading an SD card

1. Turn the power off and then open the SD card slot cover.
-
2. Insert the SD card into the slot.

To eject an SD card:

Push the card further into the slot and then pull it out.

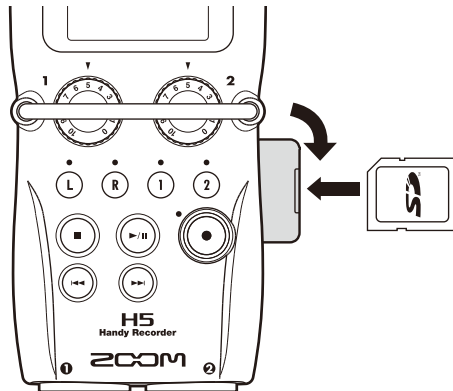

NOTE

- Always turn the power off before inserting or removing an SD card. Inserting or removing a card while the power is on could result in data loss.
- When inserting an SD card, be sure to insert the correct end with the top side up as shown.
- If an SD card is not loaded, recording and playback are not possible.
- See "Formatting SD cards:" (→ P. 106)

Turning the power on and off

Turning the power on

1. Slide  to .



NOTE

- The first time you turn the power on after purchase, you must set the date/time. (→ P. 16)
- If "No SD Card!" appears on the display, confirm that the SD card is inserted properly.
- If "Card Protected!" appears on the display, the SD card write-protection is enabled. Slide the lock switch on the SD card to disable write-protection.
- If "Invalid SD Card!" appears on the display, the card is not correctly formatted. Format the card or use a different card. See "Formatting SD cards" (→ P. 106)

Turning the power off

1. Slide  to .



NOTE

Keep sliding the switch until "Goodbye See You!" appears.

Using the hold function

The **H5** has a hold function that disables the buttons in order to prevent accidental operation during recording.

Activating the hold function

1. Slide  to HOLD.



NOTE

A remote control can still be used even when the hold function is active.



Deactivating the hold function

1. Slide  to the center.



Setting the date and time *

By setting the date and time, the recorder can store the recording date and time in files.

1. Press .

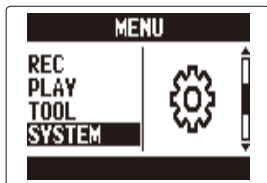
2. Use  to select
"SYSTEM", and
press .



3. Use  to select
"DATE/TIME", and
press .

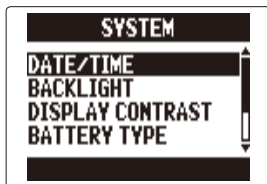

4. Change the setting.

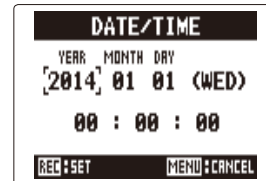

■ Changing settings

Move cursor: Move  up and down

Change item value: Press , then

move  up and down

Confirm change: Press 

5. Press .



This completes setting the date and time.

*The first time you turn it on after purchase, you must set the date and time.



Setting the type of battery used

Set the type of battery used so that the amount of remaining battery charge can be shown accurately.

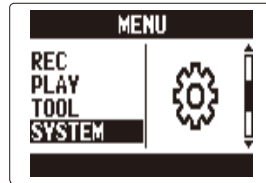

1. Press .

2. Use  to select "SYSTEM", and press .

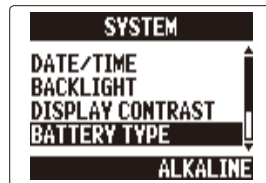

3. Use  to select "BATTERY TYPE", and press .



4. Use  to select the type, and press .

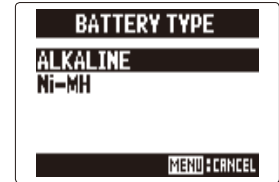

Recording process

Recording follows the process shown below.

When using the **H5** MULTI FILE mode, recording and playback data is handled in units called projects. In STEREO FILE mode, this data is handled in file units.

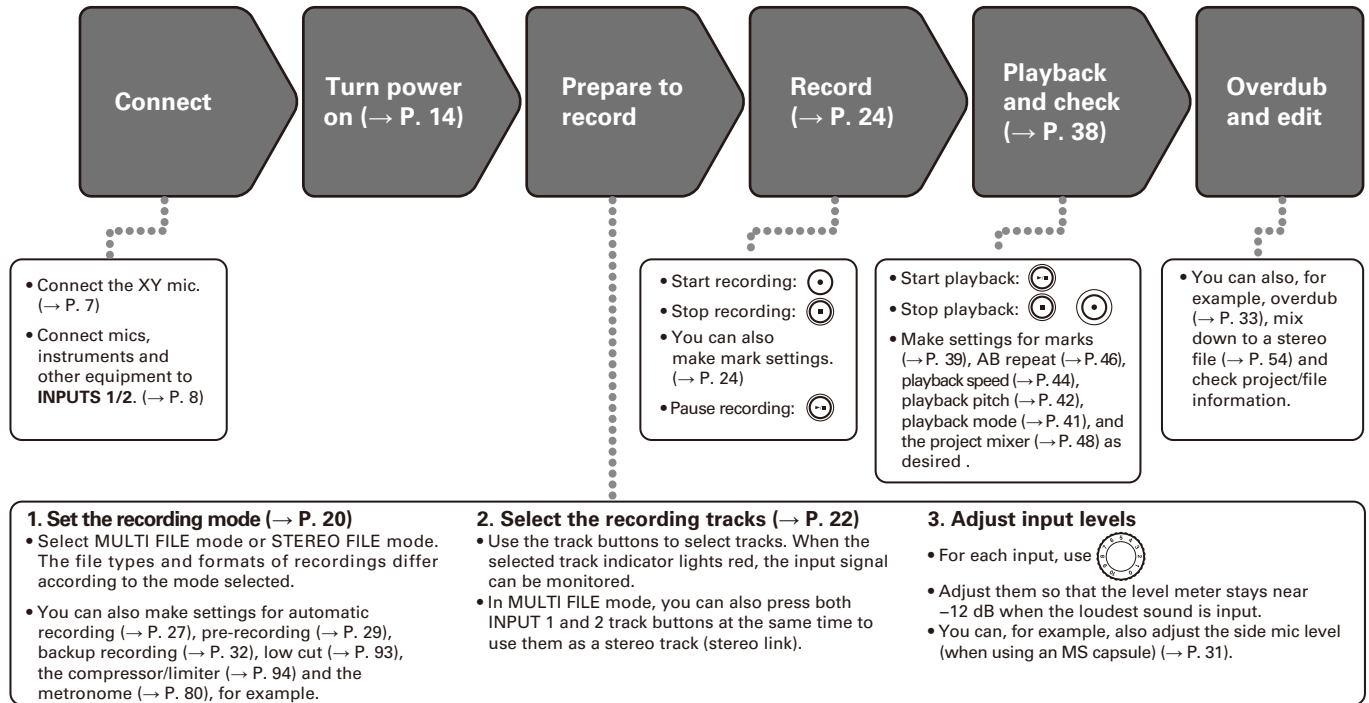

Recording mode overview

The **H5** has two recording modes: MULTI FILE and STEREO FILE.
The file types and formats of recordings differ according to the mode.

MULTI FILE mode

The L/R inputs from the XY mic or other input capsule are recorded to the L/R tracks, and Inputs 1/2 are recorded to tracks 1/2 as separate files.

Since the signals from the inputs are recorded to separate files, you can change their playback volumes and positions, for example, independently after recording.

Only 44.1/48kHz WAV formats (16/24-bit) can be selected when recording in MULTI FILE mode.

HINT

By linking Inputs 1 and 2, you can also record them together as a single stereo file. When Inputs 1 and 2 are linked, two stereo files will be created. One for the L/R inputs and one for the 1/2 Inputs.

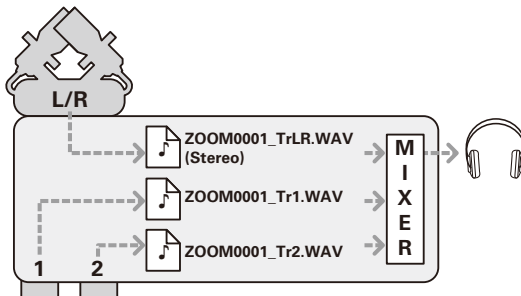

Recording format limited to 44.1/48kHz 16/24bit WAV

STEREO FILE mode

The L/R inputs from the XY mic or other input capsule and Inputs 1/2 are recorded together as a single stereo file. In this mode, only two tracks can be recorded, but you can select the recording format freely according to your purpose. (→ P. 89)

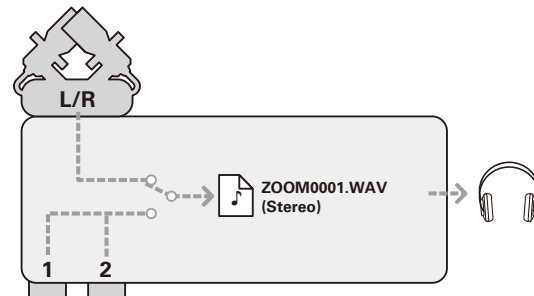

Use this mode when you want the highest audio quality or you need smaller files.





96kHz 16/24bit WAV and MP3 recording formats also okay

Selecting the recording mode

1. Press .

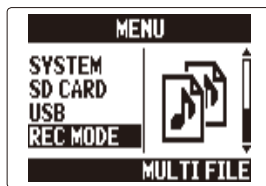
2. Use  to select
REC MODE,
and press .



3. Use  to select the
recording mode,
and press .

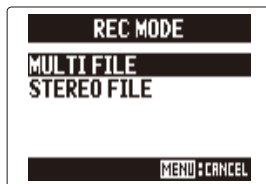

Folder and file structure on the H5

When recording with the **H5**, folders and files are created on the SD card in the following manner.

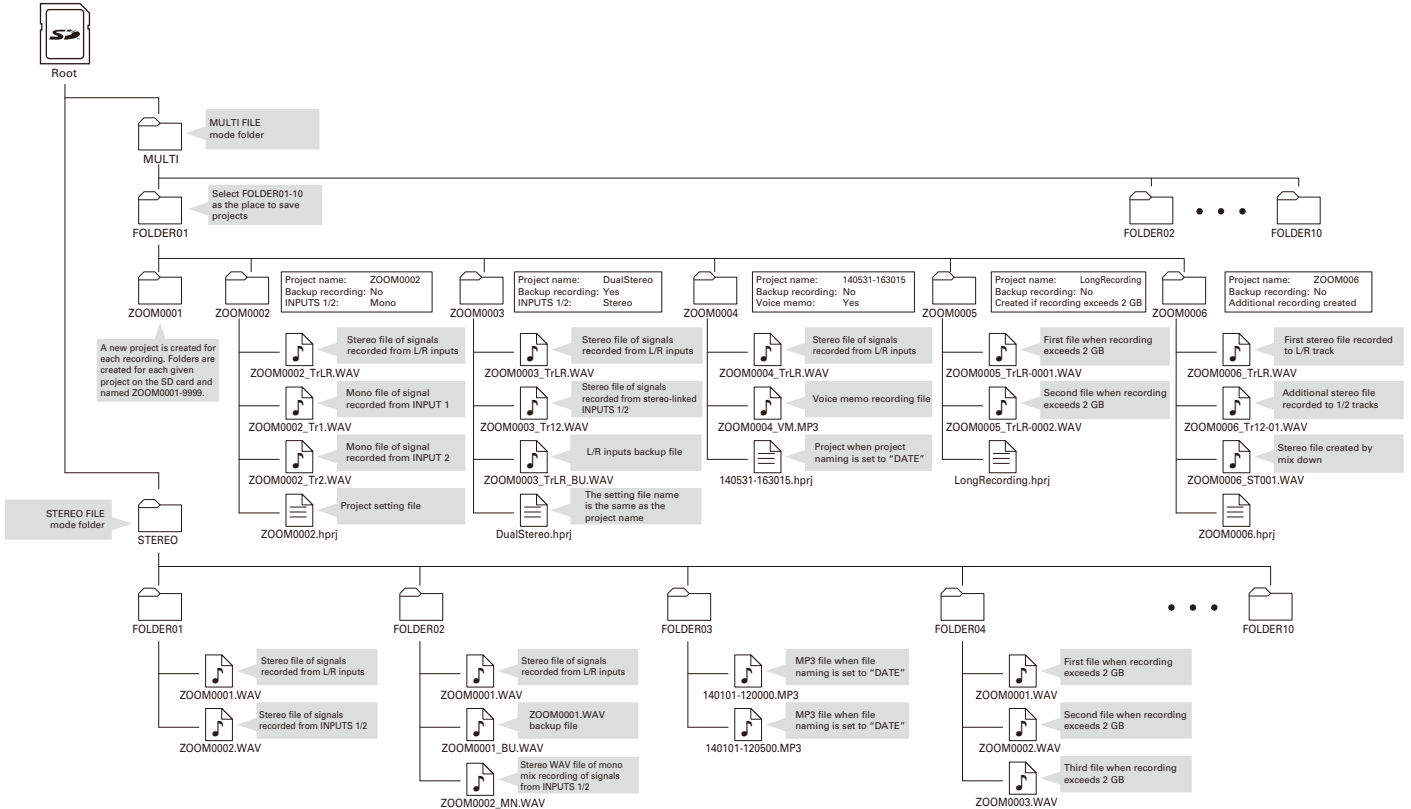

Selecting inputs and adjusting levels

Select whether to use the L/R inputs and Inputs 1/2.

In MULTI FILE mode, the L/R inputs will be recorded to the L/R tracks and Inputs 1/2 will be recorded to tracks 1 and 2.

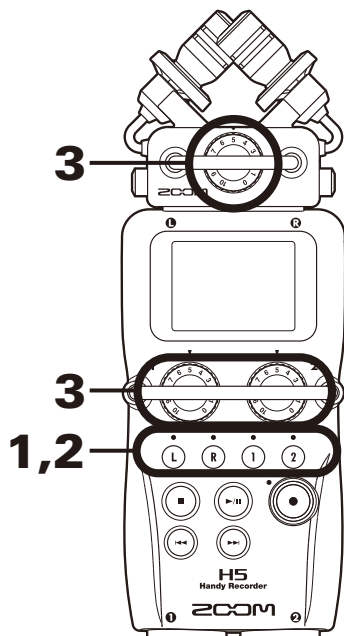

1. Press the buttons of the tracks that you want to record.

HINT

The indicators of the selected track buttons light red, and you will be able to monitor the signals input on these tracks through the headphones and line outputs.

NOTE

- In STEREO FILE mode, you can select the L/R inputs by pressing the **L** or **R** track button and Inputs 1/2 by pressing the **1** or **2** track button.
- In STEREO FILE mode, the L/R inputs and the Inputs 1/2 are selected in pairs. You cannot select just one of either pair.

When using STEREO FILE mode, skip to step 3.

2. To record Inputs 1/2 as a stereo file in MULTI FILE mode, press the **2** track button while pressing and holding **1**.

To deactivate the stereo link, press the **2** track button while pressing and holding **1** again.

HINT

If a combo type input capsule is connected to the L/R inputs, you can enable and disable the stereo link with these tracks in the same manner by pressing the (R) track button while pressing and holding (L).

NOTE**When using MULTI FILE recording mode**

- Files are created for each selected input as follows.

Track recorded	File name	Description
L/R input	ZOOMnnnn_TrLR.WAV	Stereo file
Input 1	ZOOMnnnn_Tr1.WAV	Mono file
Input 2	ZOOMnnnn_Tr2.WAV	Mono file
Input 1/2 (stereo setting)	ZOOMnnnn_Tr12.WAV	Stereo file

Note: "nnnn" in the file name is the project number

- All the files that are created during the same recording in MULTI FILE mode are managed as a single project unit.

When using STEREO FILE recording mode

- Files are created for each selected input as follows.
ZOOMnnnn.WAV/ZOOMnnnn.MP3 (stereo file)

Note: "nnnn" in the file name is the file number

- In STEREO FILE mode, this data is managed in file units.

3. Turn  for the selected input to adjust the input level.

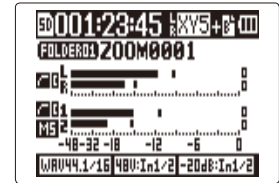

MULTI FILE mode

HINT

- Adjust so that the peak level stays around -12dB .
- If the sound distorts even when you lower the input level, try changing mic positions and adjusting the output levels of connected devices.
- The COMP/LIMITER function can be used. (→ P. 94)
- Noise from wind and other sources can be cut during recording. (→ P. 93)

Recording

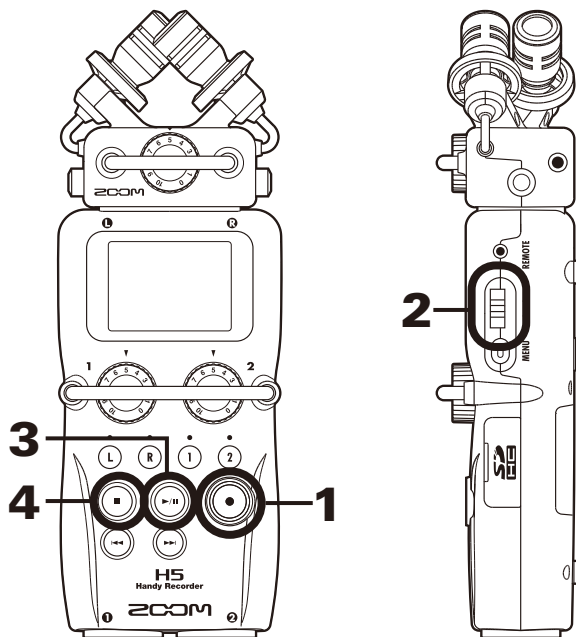

1. Press



MULTI FILE mode



STEREO FILE mode

This starts recording.

2. Press to add a mark that can be used as a reference during playback.

HINT

During playback, you can press and to jump to places where marks have been added.

NOTE

- Marks can only be added to WAV format files.

3. Press to pause.

NOTE

- When recording is paused, a mark is added at that point.
- Press to resume recording.

4. Press to stop.

NOTE

- In MULTI FILE mode, a maximum of 99 marks can be added to a single project. In STEREO FILE mode, a maximum of 99 marks can be added to a single file.
- If the file size exceeds 2 GB when recording in MULTI FILE mode, a new file will be created automatically in the same project and recording will continue without pause. When this happens, numbers will be added to the ends of the file names: "-0001" for the first file, "-0002" for the second file and so on.
- If the file size exceeds 2 GB when recording in STEREO FILE mode, a new file will be created automatically in the same folder and recording will continue without pause.

Setting where projects/files are saved

Choose one of ten folders as the folder where new recorded projects (in MULTI FILE mode) and files (in STEREO FILE mode) will be saved.

1. Press .

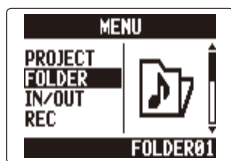

2. Use  to select "FOLDER", and press .

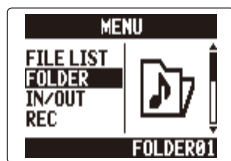

MULTI FILE mode



STEREO FILE mode

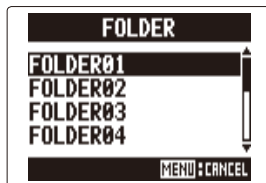

3. Use  to select the folder where you want to save, and press .



Recording automatically

Recording can be started and stopped automatically in response to the input level.

1. Press .

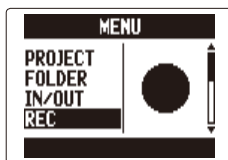

2. Use  to select "REC", and press .



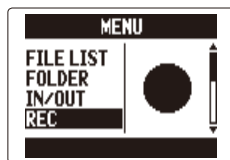

MULTI FILE mode



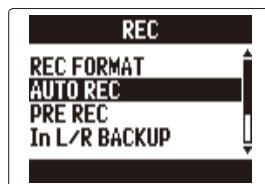

STEREO FILE mode

3. Use  to select "AUTO REC", and press .



4. Use  to select "ON/OFF", and press .



5. Use  to select "ON", and press .

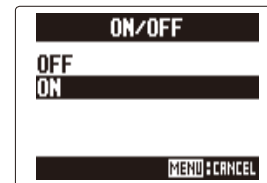

NOTE

Other automatic recording function settings can be changed. (→ P. 90)

NEXT >>>

Recording automatically (continued)

6. Return to the Home Screen.

A dotted line appears at the automatic recording start level.

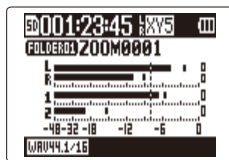

MULTI FILE mode

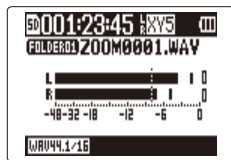

STEREO FILE mode

7. Press .

Recording standby starts.

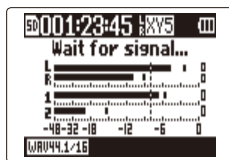

MULTI FILE mode

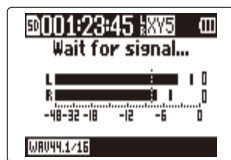

STEREO FILE mode

HINT

When the input exceeds the set level (shown on the level meters), recording starts automatically. You can also set the recording to stop automatically when the input goes below a set level. (→ P. 91)

8. Press when you want to end standby or stop recording.



MULTI FILE mode

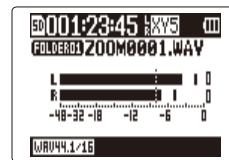

STEREO FILE mode



NOTE

This cannot be used at the same time as the PRE REC, METRONOME and PRE COUNT functions. When AUTO REC is turned ON, these other functions will be disabled.

Pre-recording

By setting the recorder to constantly capture the input signal, you can start recording two seconds before pressing the  button. This is useful when, for example, a performance starts suddenly.

1. Press .

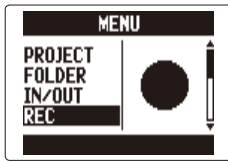

2. Use  to select "REC", and press .



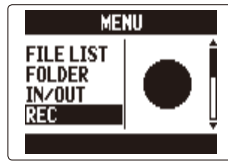

MULTI FILE mode

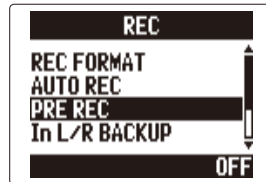

STEREO FILE mode

3. Use  to select "PRE REC", and press .



4. Use  to select "ON", and press .

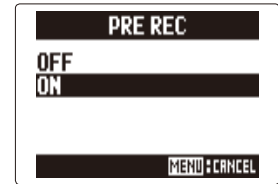



NOTE

This cannot be used at the same time as the AUTO REC, METRONOME and PRE COUNT functions. If any of these are turned ON, PRE REC will be disabled.



Counting in before recording

A count in can be set to play before starting recording.

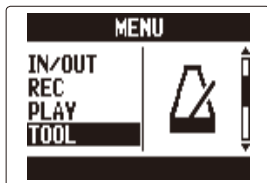

1. Press .

2. Use  to select "TOOL", and press .



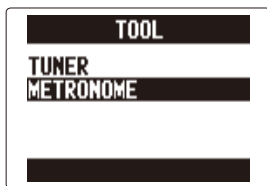

3. Use  to select "METRONOME", and press .

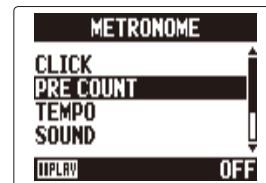

4. Use  to select "PRE COUNT", and press .



5. Use  to select the precount number, and press .

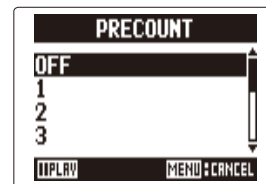

NOTE

- This cannot be used at the same time as the AUTO REC function. When AUTO REC is turned ON, PRE COUNT will be disabled.
- This cannot be used at the same time as the PRE REC function. When PRE COUNT is turned ON, PRE REC will be disabled.
- The count can be set to 1–8 or SPECIAL. Set to SPECIAL, the precount will use the following pattern.



Adjusting the side mic level

MS capsule only

When using an input capsule that allows the side mic level (stereo width) to be adjusted, such as an MS capsule, you can adjust the side mic level before recording.

1. Use  to adjust the side mic level

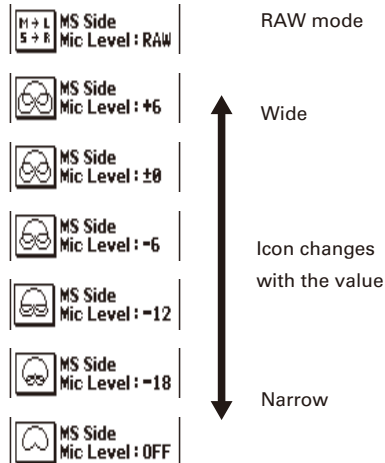

NOTE

- Set to Off, -24 to +6 dB, or MS-RAW mode.
- When recording in MS-RAW mode, during playback move  up and down to adjust the side mic level.
- However, this format is different from an ordinary stereo file, so you will need to use ZOOM MS Decoder or other software that can convert it to normal stereo in order to use it with other equipment.
- MS-RAW mode can be selected only when the WAV format is used for recording.

Backup recording

L/R input only (with 44.1/48kHz WAV only)

When using the L/R input, in addition to the recording at the set input level, the recorder can also record a separate file at a level 12dB below. This backup can be used if the recording level was set too high, causing distortion, for example.

1. Press .

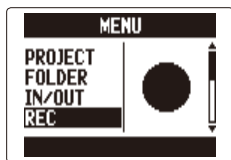

2. Use  to select "REC", and press .

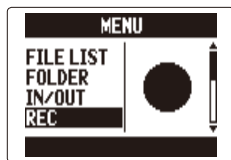

MULTI FILE mode



STEREO FILE mode

3. Use  to select "In L/R BACKUP", and press .

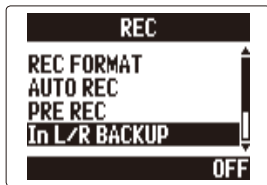

4. Use  to select "ON", and press .

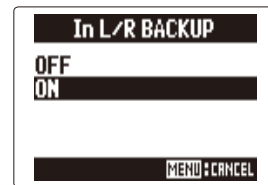

NOTE

- If the name of the original file is, for example, "ZOOM0001_TrLR.wav", the name of the backup file will be "ZOOM0001_TrLR_BU.wav".
- A backup file will not be created if the L/R input is not selected.
- The LO CUT and COMP/LIMITER settings will not affect the backup recording.
- To play a backup recording file, select and play the file with "_BU" added to the end of the file name. (For MULTI FILE mode, see step 12 → P. 35. For STEREO FILE mode, see → P. 40.)



HINT

Using backup recording will increase the amount of SD card space used.



Overdubbing MULTI FILE mode only (with 44.1/48kHz WAV only)

You can add recordings later to an already recorded project.

1. Press .

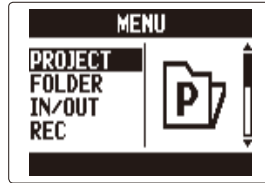
2. Use  to select "PROJECT", and press .



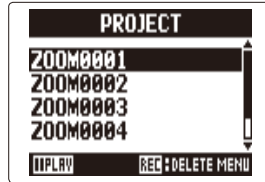

3. Use  to select the project you want to overdub, and press .





HINT

You can only overdub recordings in projects recorded using MULTI FILE mode.

4. Use  to select "MIXER/OVERDUB", and press .



5. Use  to select "MIXER/OVERDUB", and press .



The track button indicators light green for already recorded tracks and are unlit for unrecorded tracks.

Cursor (selected track)
Shows setting values

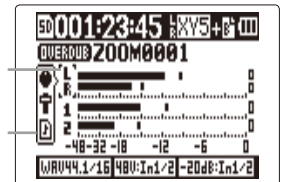

NEXT >>>

- 6.** Press the track button for the track you want to overdub. Its indicator will light red.

You will now be able to monitor the input signal for the track to be overdubbed.

HINT

You can also change the Input 1/2 stereo link setting. (→ P. 22)

- 7.** Turn  to adjust the input level.

- 8.** To play back an already recorded track while overdubbing, press that track's button to light the indicator green.

HINT

- The indicators change in order: red → green → unlit.
- In this state, if you press , you can monitor the sound of the selected tracks being played back along with the input signal of the track selected in step 6. This is useful for rehearsing and checking the input level.
- You can also adjust the volume and panning of the tracks that are playing back.

- 9.** Press .

Overdubbing of the track selected in step 6 starts.

NOTE

- The AUTO REC and PRE REC functions cannot be used with overdubbing.
- When using the MIXER/OVERDUB screen, the PLAYBACK SPEED and KEY CONTROL settings for the project are disabled.

HINT

Even if the overdubbed track already had a recorded file, the original file will not be overwritten. A new file will be created that can be assigned to any track. The name of the new recorded file will be the track name with a two-digit take number added to the end, like "ZOOM0001_TrLR-01.WAV".

After you are done recording, you can assign any files to any tracks.

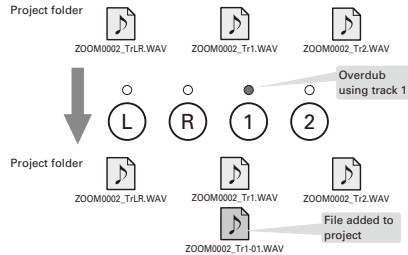
**10.** Press  to stop.



The track selected for overdubbing in step 6 will no longer be record ready and its indicator will light green.

11. To check the recording, press .



The audio from tracks with indicators that are lit green will play back.

HINT

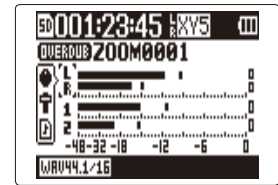

By using the MIX DOWN function, you can combine overdubbed recordings into a stereo file. (→ P. 54)

- 12.** To change the track that the recording file is assigned to, use  to select the track, and press .

**NEXT >>>**

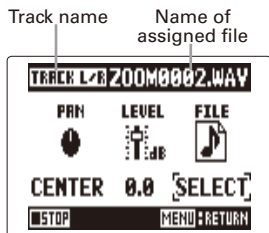
- 13.** Use  to select FILE,
and press .



- 14.** Use  to select the
file, and press .



From the same project folder, select the WAV file that you want to assign to the track.

Press  to cancel file assignment.

NOTE

- If the selected track is stereo, you can only assign a stereo file to it. If it is mono, you can only assign a mono file.
- Files recorded in MS RAW mode cannot be assigned to tracks 1/2.

HINT

- By selecting "NONE", you can also remove an assigned file from a track.
- By selecting and playing back a mixed down file while overdubbing new tracks, you can layer recordings repeatedly. (→ P. 54)

- 15.** To end overdubbing, press .

After adding a recording, the audio files assigned to the tracks will be used when playing back and editing the project.

Basic playback

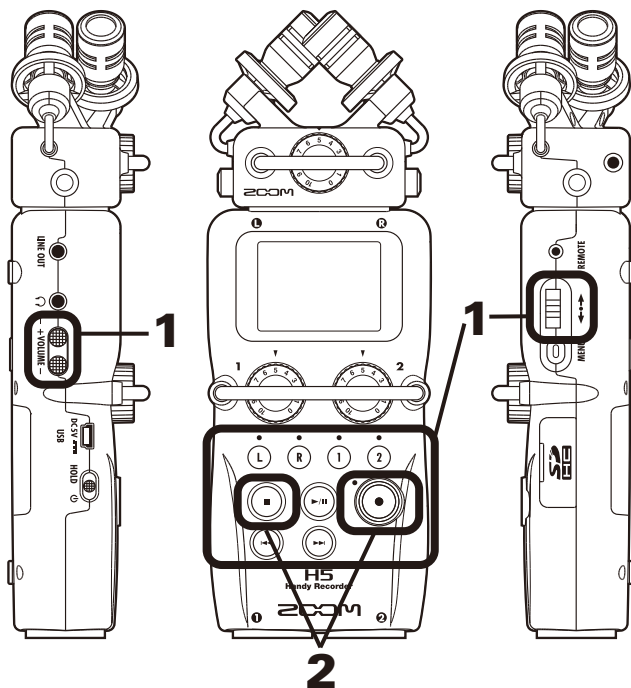

1. Press



MULTI FILE mode

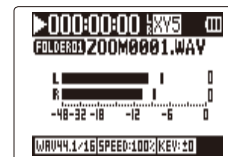

STEREO FILE mode

■ Controls during playback

Select playback project/file or move to a mark:

Use and

Search forward/backward:

Press and hold /

Pause/resume playback:

Press

Change side mic level:

(MS-RAW mode only)

Move up/down

HINT

- The longer you press and hold or , the faster searching backward/forward becomes.
- In MULTI FILE mode, during playback you can press track buttons to unmute (lit green) and mute (unlit) them.
- If there is a problem with the selected project /file, "Invalid Project!" or "Invalid File!" will appear on the display.
- If there is not even one project /file that can be played, "No Project!" or "No File!" will appear on the display.

■ Add a mark during playback

Press  at the point where you want to add a mark.



HINT

A maximum 99 marks can be added.

NOTE

- Marks can only be added to WAV format files.

■ Adjusting the volume during playback

Press .



Speaker



Headphones

HINT

You can adjust the volume of the speaker and headphones independently. You can set them from 0–100.

2. To return to the Home Screen, press  or .

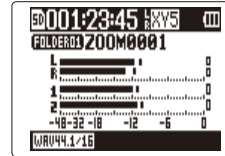



MULTI FILE mode



STEREO FILE mode

Selecting playback project/files from lists

1. Press .

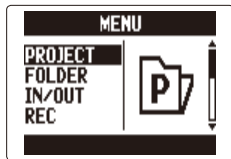

2. Use  to select "PROJECT"/"FILE LIST", and press .



MULTI FILE mode



STEREO FILE mode

3. Use  to select the project/file to be played, and press .





MULTI FILE mode



STEREO FILE mode

HINT

You can also press  to start playback of the selected project/file.

4. Use  to select "PLAY", and press .



MULTI FILE mode

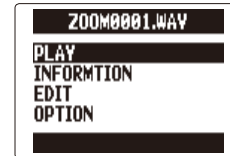

STEREO FILE mode

The selected project will start playing back.



NOTE

After playback completes, playback might continue depending on the playback mode. (→ P. 41)



Changing the playback mode

You can set the playback mode.

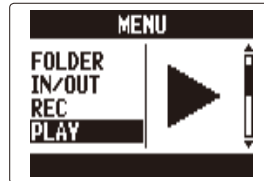

1. Press .

2. Use  to select "PLAY", and press .



3. Use  to select "PLAY MODE", and press .



4. Use  to select the playback mode, and press .



NOTE

PLAY ONE: Play only the selected project/file.

PLAY ALL: Play from the selected project/file to the last project/file.

REPEAT ONE: Play the selected project/file repeatedly.

REPEAT ALL: Play all the projects/files in the selected folder repeatedly.

Changing the playback pitch (key)

The pitch can be changed while keeping the same playback speed.

1. Press .

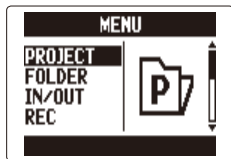

2. Use   to select "PROJECT/FILE LIST", and press .



MULTI FILE mode



STEREO FILE mode



3. Use   to select the project /file to adjust, and press .



MULTI FILE mode



STEREO FILE mode

4. Use   to select "OPTION", and press .



MULTI FILE mode



STEREO FILE mode

5. Use   to select "KEY CONTROL", and press .

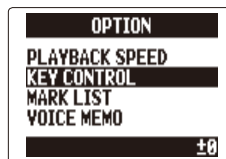

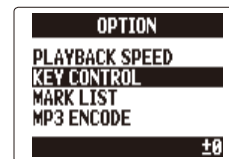

MULTI FILE mode



STEREO FILE mode

NOTE

In MULTI FILE mode, the pitch change will affect the entire project, and cannot be set for each track independently.

6. Use  to set the playback pitch,
and press .

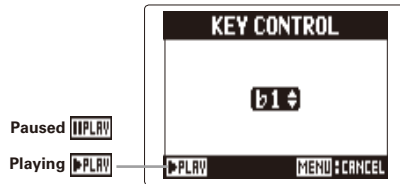

Playback will occur with the changed pitch. The pitch can be changed even during playback.

NOTE

- That pitch change can be set between $\flat 6$ and $\sharp 6$.
- In MULTI FILE mode, the changed value is saved separately for each project.
- In STEREO FILE mode, the changed value is saved for the mode.
- On the MIXER/OVERDUB screen, KEY CONTROL is disabled.

Changing the playback speed

You can adjust the playback speed in a range from 50% to 150% of normal.

1. Press .

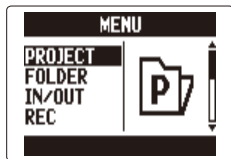

2. Use  to select "PROJECT/FILE LIST", and press .



MULTI FILE mode



STEREO FILE mode



3. Use  to select the project /file to adjust, and press .



MULTI FILE mode



STEREO FILE mode

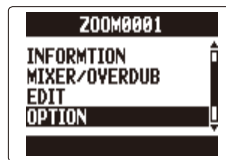

4. Use  to select "OPTION", and press .



MULTI FILE mode



STEREO FILE mode

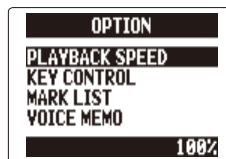

5. Use  to select "PLAYBACK SPEED", and press .

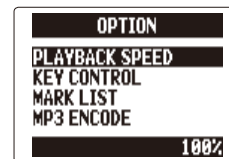

MULTI FILE mode



STEREO FILE mode

6. Use  to adjust the playback speed, and press .

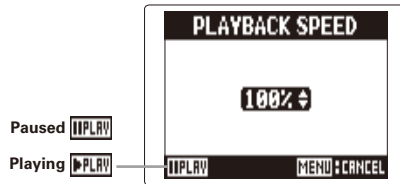

Playback will occur at the adjusted speed. The speed can be changed even during playback.



NOTE

- This speed can be changed to between 50% and 150% of normal.
- In MULTI FILE mode, the changed value is saved separately for each project.
- In STEREO FILE mode, the changed value is saved for the mode.
- On the MIXER/OVERDUB screen, PLAYBACK SPEED is disabled.



Repeat playback of a set interval (AB repeat)

You can repeat playback between two set points.

1. Press .

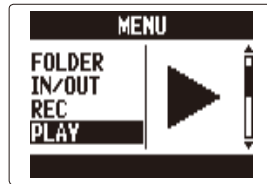
2. Use  to select "PLAY", and press .





3. Use  to select "AB REPEAT", and press .



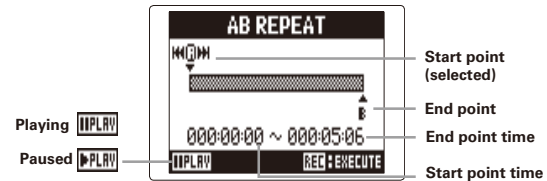



4. Use  to select the A point icon.

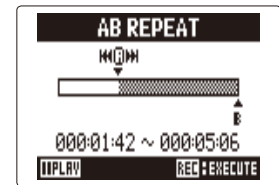

5. Use  and  to find the starting point for repeat playback.





You can also press  to search while playing back.

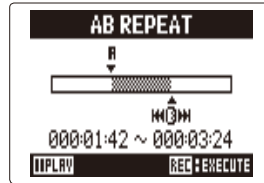

6. Use    to select the B point icon, and set the repeat playback ending point.

**NOTE**

You can end A-B repeat playback by doing one of the following during repeat playback.

- Press  or  to select a different project /file.
- Press  or  to stop playback.

7. Press .

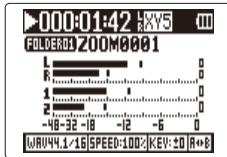

MULTI FILE mode



STEREO FILE mode



The playback screen will appear, and repeat playback will start between the set points.

Mixing projects



MULTI FILE mode only

You can adjust the volume and panning of each playback track.

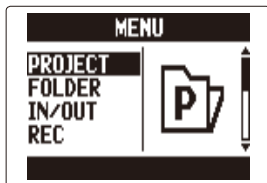

1. Press .

2. Use  to select "PROJECT", and press .



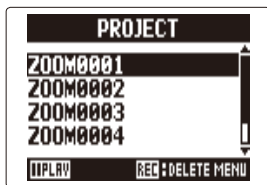

3. Use  to select the project to mix, and press .





4. Use  to select "MIXER/OVERDUB", and press .



5. Use  to select "MIXER/OVERDUB", and press .



6. Use  to select the track to adjust, and press .

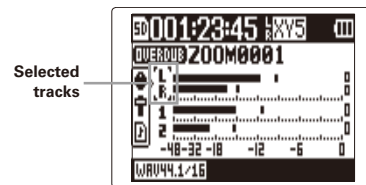

7. Change parameter values.

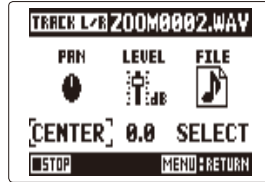

■ **Mixing controls**

Move cursor/change value: Move  up/down

Select parameter to change: Press 

Parameter	Setting range	Explanation
PAN	L100 – CENTER – R100	Adjusts left–right sound balance
LEVEL	Mute, –48.0 – +12dB	Adjusts volume

NOTE
Mix settings are saved with each project separately and applied during playback.

HINT
Do the following to check the LO CUT, COMP/LIMITER and MS STEREO MATRIX settings.

Track L or L/R selected 

Track 2 or 1/2 selected 

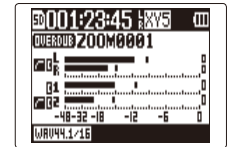

Checking project/file information

You can check a variety of information about the selected project.

1. Press (O) MENU.

2. Use \updownarrow to select "PROJECT/FILE LIST", and press \rightarrow .

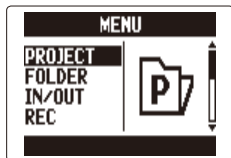

MULTI FILE mode



STEREO FILE mode

3. Use \updownarrow to select the project /file to check, and press \rightarrow .



MULTI FILE mode



STEREO FILE mode

4. Use \updownarrow to select "INFORMATION", and press \rightarrow .

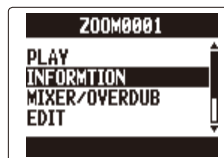

MULTI FILE mode

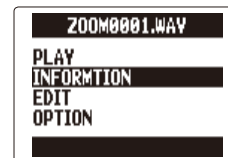

STEREO FILE mode

Project information will be shown.

Use \updownarrow to scroll to see hidden information.

Item	Explanation
NAME	Project name (MULTI FILE mode only)
PATH	Location where project /file is saved
DATE	Project /file creation date and time (Y/M/D H:M:S)
FORMAT	Recording format
SIZE	Total project /file size
TIME	Project /file length (HHH:MM:SS) (Maximum is 999:59:59)
MS MIC	MS side level or "RAW" "—" when an MS capsule not used
FILES	Information about tracks/files

Checking track marks WAV format only

A list of the marks in the recorded project/file can be shown.

1. Press .

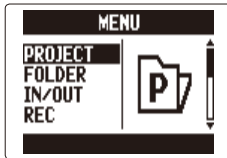

2. Use  to select "PROJECT/FILE LIST", and press .



MULTI FILE mode



STEREO FILE mode

3. Use  to select the project /file to check, and press .



MULTI FILE mode



STEREO FILE mode

4. Use  to select "OPTION", and press .



MULTI FILE mode



STEREO FILE mode

5. Use  to select "MARK LIST", and press .

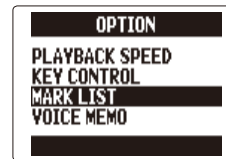

MULTI FILE mode

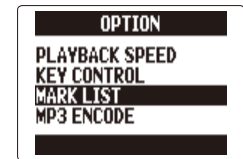

STEREO FILE mode

The MARK LIST will be shown.

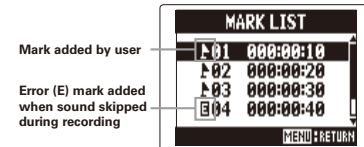

HINT

Press  to start playback from the mark position.

Changing project/file names

1. Press .

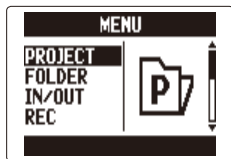

2. Use  to select "PROJECT/FILE LIST", and press .



MULTI FILE mode



STEREO FILE mode

3. Use  to select the project /file name to change, and press .



MULTI FILE mode



STEREO FILE mode



4. Use  to select "EDIT", and press .

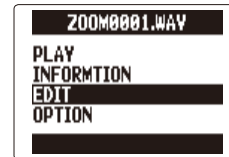

MULTI FILE mode



STEREO FILE mode

5. Use  to select "RENAME", and press .

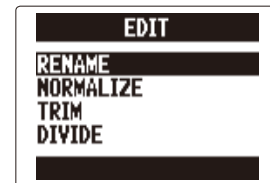

6. Change the name.



■ Controls when changing

Move cursor/change character: Move  up/down

Select character/confirm change: Press 

NOTE

- The following characters can be used in project/file names.
(SPACE) !#\$% &'()+,-.0123456789;=@ABCDEFGHIJKLMNQRSTU-
VWXYZ[]^_`abcdefghijklmnopqrstuvwxyz{ }~
- A project/file name cannot be only spaces.
- In MULTI FILE mode, file names cannot be changed.



7. Press .

Mixing down a project



MULTI FILE mode only

You can mix down a project that has been recorded using MULTI FILE mode into a stereo WAV file.

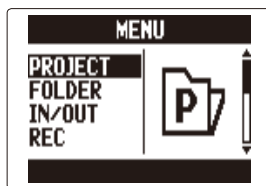

1. Press .

2. Use  to select "PROJECT", and press .

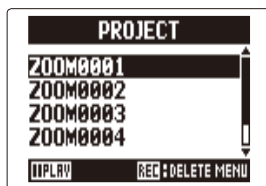

3. Use  to select a project, and press .



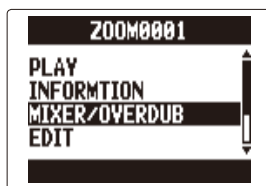

4. Use  to select "MIXER/OVERDUB", and press .





5. Use  to select "MIX DOWN", and press .



6. To change where the mix down file is saved, use  to select "SAVE TO", and press .



7. Use  to select where to save it and press .



8. Use \updownarrow (with a vertical bar icon) to select the project / folder where it will be saved, and press \rightarrow (with a vertical bar icon).

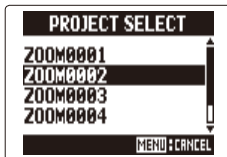

MULTI FILE mode

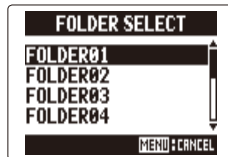

STEREO FILE mode

9. To change the file name, use \updownarrow (with a vertical bar icon) to select "NAME", and press \rightarrow (with a vertical bar icon).

**HINT**

See step 6 of "Changing project/file names" (\rightarrow P. 52) for how to change the file name.

10. Use \updownarrow (with a vertical bar icon) to select "EXECUTE", and press \rightarrow (with a vertical bar icon).



This will start the mix down.

NOTE

- The volume and pan settings (\rightarrow P. 49) made using MIXER/OVERDUB (\rightarrow P. 48) will affect the sound of the mix down.
- The file created will have the same sampling frequency and bit rate as the project that was mixed down.

Converting WAV files to MP3 files

STEREO FILE mode only

STEREO FILE mode WAV files can be converted to (encoded into) MP3 files.

1. Press $\left(\text{MENU}\right)$.

2. Use $\updownarrow\left(\text{CURSOR}\right)$ to select "FILE LIST", and press $\rightarrow\left(\text{CURSOR}\right)$.



3. Use $\updownarrow\left(\text{CURSOR}\right)$ to select a file, and press $\rightarrow\left(\text{CURSOR}\right)$.



NOTE

Files recorded using MS-RAW mode cannot be converted (encoded).

4. Use $\updownarrow\left(\text{CURSOR}\right)$ to select "OPTION", and press $\rightarrow\left(\text{CURSOR}\right)$.



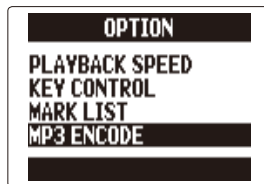

5. Use $\updownarrow\left(\text{CURSOR}\right)$ to select "MP3 ENCODE", and press $\rightarrow\left(\text{CURSOR}\right)$.



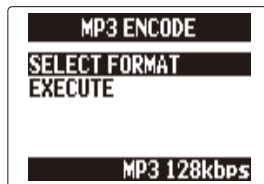

6. To change the format used for encoding, use $\updownarrow\left(\text{CURSOR}\right)$ to select "SELECT FORMAT", and press $\rightarrow\left(\text{CURSOR}\right)$.

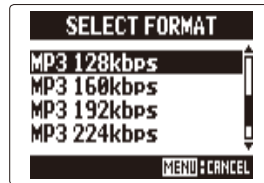

- 7.** Use  to select the format, and press .



- 8.** Use  to select "EXECUTE", and press .

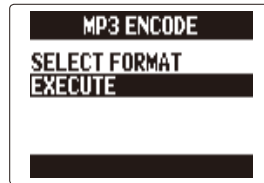

Encoding will start.

NOTE

- If the SD card does not have enough open space, the screen shown in step 6 will reappear.
- The new encoded file will be created in the same folder.
- If the name of the encoded file would be the same as an existing file, the file name change screen will appear. Change the name before encoding.

Normalizing WAV format only

If the volume of a project recorded using WAV format is too low, you can increase the overall levels of files.

1. Press .

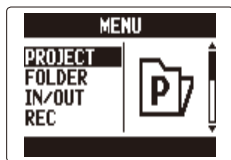

2. Use  to select "PROJECT/FILE LIST", and press .



MULTI FILE mode



STEREO FILE mode

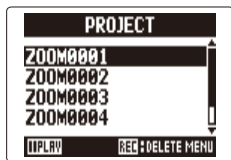

3. Use  to select the project /file to normalize, and press .



MULTI FILE mode



STEREO FILE mode



4. Use  to select "EDIT", and press .

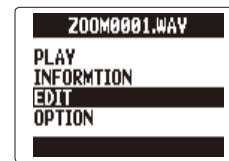

MULTI FILE mode



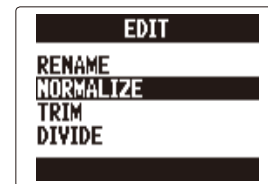

STEREO FILE mode

5. Use  to select "NORMALIZE", and press .



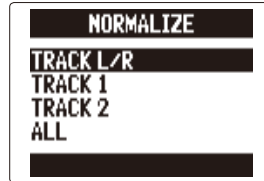

In STEREO FILE mode, skip to step 7.

6. Use  to select the track to normalize, and press .

**NOTE**

- You cannot select a track that has no recorded file.
- If you select "ALL", all tracks that have files will be normalized. This normalization will maximize the level of each individual file.
- If there are multiple recordings, including overdubs, the file currently selected for the track will be normalized.

7. Use  to select "YES", and press .



MULTI FILE mode



STEREO FILE mode

NOTE

When normalized, the level of the entire file will be increased by the same amount so that the peak level is 0 dBFS.

Dividing projects/files

You can divide a project /file into two at any point.

1. Press (O) MENU.

2. Use \updownarrow (O) \updownarrow to select "PROJECT/FILE LIST", and press \rightarrow (O) \updownarrow .

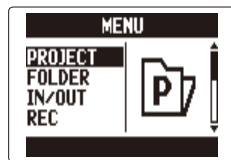

MULTI FILE mode



STEREO FILE mode

3. Use \updownarrow (O) \updownarrow to select the project /file to divide, and press \rightarrow (O) \updownarrow .

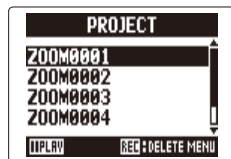

MULTI FILE mode



STEREO FILE mode

4. Use \updownarrow (O) \updownarrow to select "EDIT", and press \rightarrow (O) \updownarrow .



MULTI FILE mode

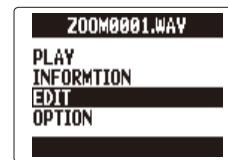

STEREO FILE mode

5. Use \updownarrow (O) \updownarrow to select "DIVIDE", and press \rightarrow (O) \updownarrow .



6. Set the division point.

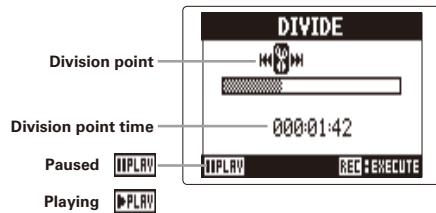

■ Controls when dividing

Move point: Use and

Play/pause: Press

Confirm point: Press

7. Use to select "YES", and press .



NOTE

- After dividing a project, the part before the division point will be given the same name as the original project with "A" added to the end. The part after the point will have "B" added to the end of its name.
- If there are multiple recordings, including overdubs, the file currently selected for the track will be divided. All other files will be saved with the project for the part before the division point.

Trimming project beginnings and ends

You can delete (trim) unnecessary beginnings and endings of recorded projects. To do so, you will set the beginning and ending points of the part to be kept.

1. Press .

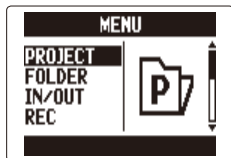

2. Use  to select "PROJECT/FILE LIST", and press .



MULTI FILE mode



STEREO FILE mode



3. Use  to select the project /file to trim, and press .



MULTI FILE mode



STEREO FILE mode



4. Use  to select "EDIT", and press .



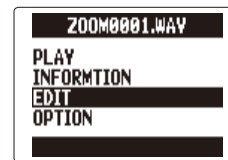

MULTI FILE mode



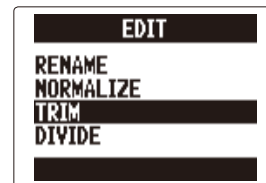

STEREO FILE mode

5. Use  to select "TRIM", and press .



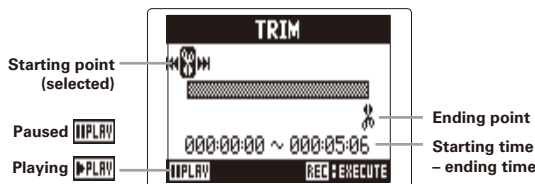



6. Use  to select the starting point icon.

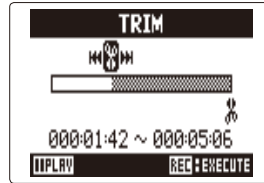

7. Use  and  to find the starting point.

**HINT**



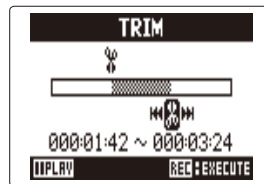

You can also press  and search while playing back.

8. Use    to select the ending point icon.

Then, set the ending point in the same manner.



9. Press .

10. Use    to select "YES", and press  .

**NOTE**

If there are multiple recordings, including overdubs, the file currently selected for the track will be trimmed.

Deleting multiple files

You can delete unneeded files.

1. Press .

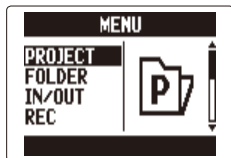

2. Use  to select "PROJECT/FILE LIST", and press .

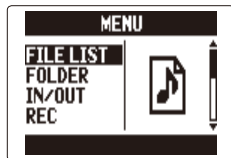

MULTI FILE mode



STEREO FILE mode

3. In MULTI FILE mode, use  to select project, and press .

In STEREO FILE mode, press .





MULTI FILE mode





STEREO FILE mode

In STEREO FILE mode, skip to step 5.

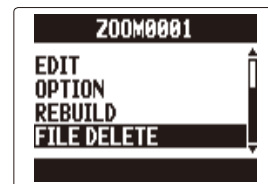
4. Use  to select "FILE DELETE", and press .



5. Use  to select a file to delete, and press .









Press  to cancel file deletion.

NOTE

Press  to select/unselect all files.

6. Press .



- 7.** Use     to select "YES", and press   .



Deleting multiple projects MULTI FILE mode only

You can delete multiple projects in the selected folder at one time.

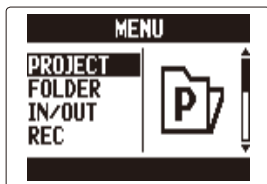

1. Press .

2. Use  to select "PROJECT", and press  .

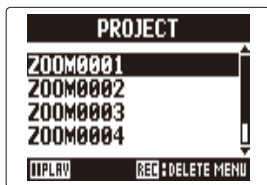

3. Press .



4. Use  to select a project to delete, and press  .





Press  to cancel project deletion.

NOTE

Press  to select/unselect all projects.

5. Press .

6. Use  to select "YES", and press  .





Rebuilding a project



MULTI FILE mode only

If a project is missing necessary files or is damaged, you can rebuild it.

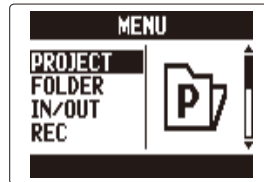

1. Press .

2. Use  to select "PROJECT", and press .



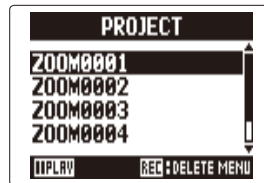

3. Use  to select the project to rebuild, and press .



4. Use  to select "REBUILD", and press .



5. Use  to select "YES", and press .



HINT



A project will not play back if you accidentally disconnect the adapter or remove the SD card while recording or if you use a computer to delete a setting file that the project requires. In such cases, rebuilding the project might repair it.

Adding voice memos



MULTI FILE mode only

You can add voice memos to projects.

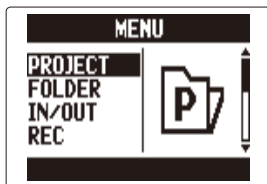

1. Press .

2. Use  to select "PROJECT", and press .



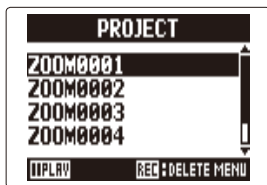

3. Use  to select a project to which you want to add a voice memo, and press .



4. Use  to select "OPTION", and press .



5. Use  to select "VOICE MEMO", and press .

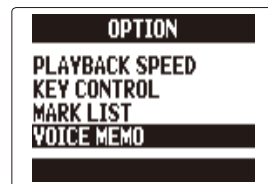

6. Record the memo.

Start recording: Press .

Stop recording: Press  or .

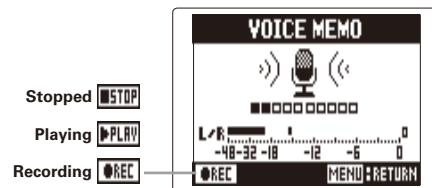

7. Play the memo.

Start playback: Press 

Stop playback: Press 





HINT

- Every time you press  the voice memo will be overwritten.
- Voice memos are recorded using the stereo mic connected to the L/R inputs. They cannot be recorded using Inputs 1/2.
- The file name of the voice memo will be in the format of "ZOOM0001_VM". The recording format is 128kbps MP3.



Data exchange with computers (card reader)

By connecting with a computer, you can check and copy data on the SD card.

1. Press .

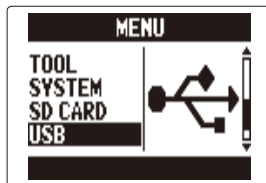
2. Use  to select "USB", and press .



3. Use  to select "SD CARD READER", and press .

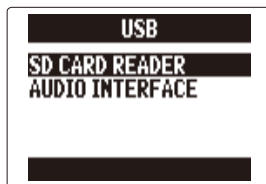

4. Connect the **H5** to the computer using a USB cable.

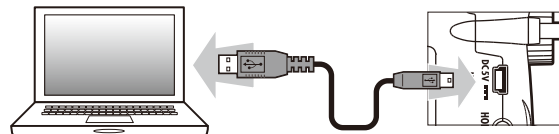

NOTE

- If you want to power the **H5** using the computer's USB bus, connect the cable while the recorder is off and then turn it on.
- The following operating systems are supported.
 - Windows Vista or later
 - Mac OS X 10.6 or later

5. Follow the disconnection procedures for the computer before disconnecting the USB cable.

Windows:

Use "Safely Remove Hardware" to select the **H5**.

Mac:

Drag-and-drop the **H5** icon into the trash.

NOTE



Always follow these procedures before disconnecting the USB cable.

-
6. Disconnect the cable from the computer and the **H5**, and then press .



Using as an audio interface

You can send signals input through the **H5** directly to a computer or iPad as well as output signals from that device through the **H5**.

1. Follow steps 1–2 in "Data exchange with computers (card reader)" (→ P. 70).

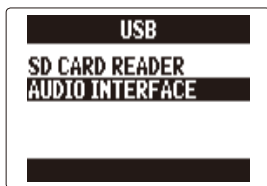
2. Use  to select "AUDIO INTERFACE", and press .





3. Use  to select "STEREO" or "MULTI TRACK", and press .



NOTE

- Set to "STEREO" to use it as a 2-in/2-out interface or "MULTITRACK" to use it as a 4-in/2-out interface.
- When using an iPad, select "STEREO". It cannot be used with MULTITRACK mode.
- When using Windows, a driver is necessary to use MULTITRACK mode. You can download this driver from the ZOOM website (www.zoom.co.jp).

4. Use  to select the connected device, and press .



STEREO



MULTITRACK

HINT

If using a computer that does not provide enough power through its USB bus or using phantom power, select "PC/Mac (Battery)".

5. Connect the **H5** to the computer or iPad using a USB cable.

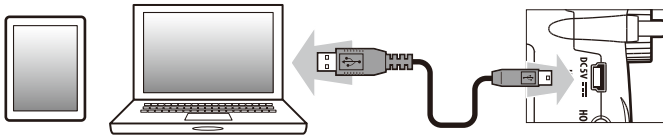

NOTE

An iPad Camera Connection Kit is necessary to connect an iPad.

HINT

See "Audio interface settings" (→ P. 74)

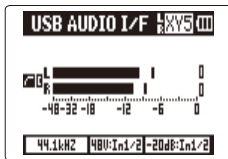

STEREO

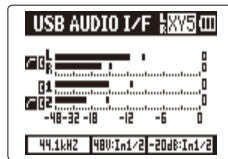

MULTITRACK

6. Press to disconnect.

7. Use to select "EXIT", and press .

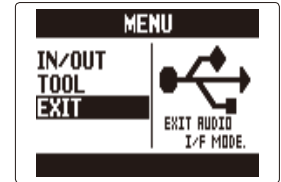

8. Use to select "YES", and press .



9. Disconnect the cable from the computer or iPad and the **H5**.



Audio interface settings

When using the **H5** as an audio interface, you can make the following settings. Refer to each section for details.

Input settings	LO CUT (→ P. 93)
	COMP/LIMITER (→ P. 94)
	In1/2 PHANTOM (→ P. 96)
	PLUGIN POWER (→ P. 97)
	In1/2 PAD(-20dB) (→ P. 98)
	1/2 MS STEREO MATRIX (→ P. 86)
	L/R MS-RAW MONITOR (→ P. 85)
	DIRECT MONITOR (→ P. 74)
	MONITOR MIXER (→ P. 75) (MULTITRACK only)
LOOP BACK (→ P. 77) (STEREO only)	
In1/2 MONO MIX (→ P. 88) (STEREO only)	
LINE OUT LEVEL (→ P. 84)	
Tool	TUNER (→ P. 78)

Making direct monitoring settings

Sound that is input to the **H5** can be output directly before it passes through the connected computer or iPad. This enables monitoring without latency.

1. Press .
-
2. Use  to select "IN/OUT", and press .

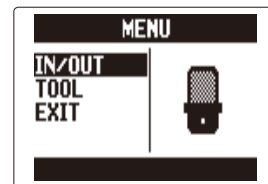

3. Use  to select "DIRECT MONITOR", and press .

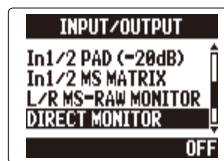

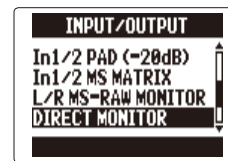

STEREO





MULTITRACK

For STEREO skip to set 5.

4. Use  to select "ON/OFF", and press .



MULTITRACK

5. Use  to select "ON", and press .

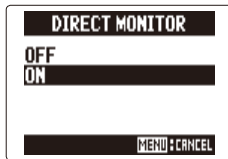

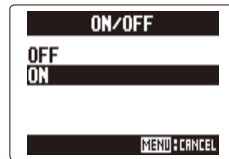

STEREO





MULTITRACK

Monitor signal mixing (MULTITRACK only)

When using direct monitoring you can adjust the balance of the input signals. This mix does not affect the input signals sent to the computer or iPad.

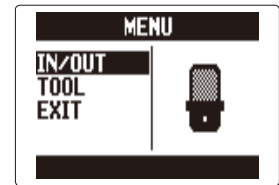

1. Press .
2. Use  to select "IN/OUT", and press .

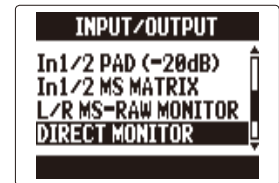

3. Use  to select "DIRECT MONITOR", and press .





Audio interface settings (continued)

4. Use  to select "MONITOR MIXER", and press .

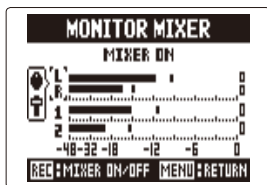

5. Use  to select track, and press .



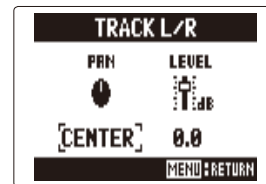

6. Use  to select the parameter, and change the value.



■ Mixing controls

Move cursor/change value: Move  up/down

Select parameter to change: Press 

7. Press  to listen to the project without mixer adjustments.

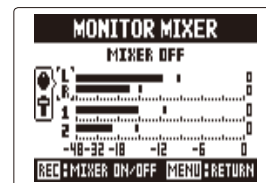



Pressing this button turns the mixer on and off.



Using Loop Back (STEREO only)

When in STEREO mode, you can mix the sound from the computer or iPad with the sound input through the **H5** and send it back to the computer or iPad again (loop back). This can be used, for example, to add narration to a musical backing track playing on a computer, and then record it using software on the computer or stream it live via the Internet.

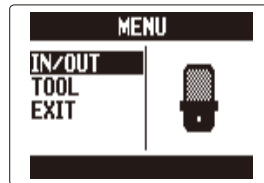

1. Press .

2. Use  to select "IN/OUT", and press .

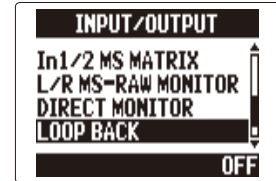

3. Use  to select "LOOP BACK", and press .



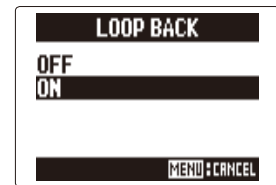

4. Use  to select "ON", and press .





Using the tuner

You can use the input signal to tune an instrument.

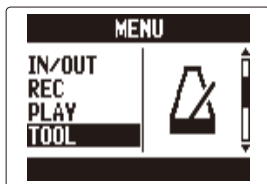

1. Press .

2. Use  to select "TOOL", and press .

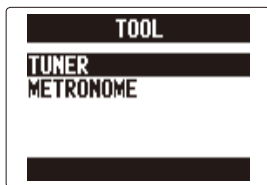

3. Use  to select "TUNER", and press .



4. Use  to select the type of tuning, and press .

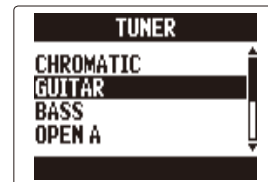

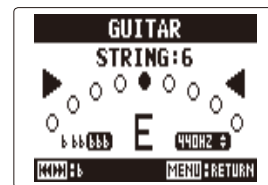

5. Use  to change the standard pitch.



HINT

The standard pitch can be set from 435 Hz to 445Hz.

- 6.** For all tuner types except chromatic, you can use  and  to change the pitch (drop tuning).

HINT

You can drop the tuning by up to three semitones.

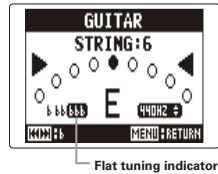

- 7.** Press a track button to select the input to use.

- 8.** Using the tuner.
The following tuner types can be selected.

■ Chromatic tuner

The input pitch is detected automatically and the name of the nearest note and the pitch inaccuracy are shown.

Center lights when pitch accurate

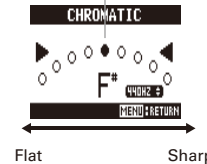

■ Guitar/bass tuner

The number of the string you are tuning is automatically detected, allowing you to tune them one at a time.

Center lights when pitch accurate

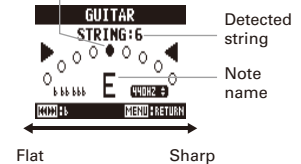

Tuner type	String number/note name						
	1	2	3	4	5	6	7
Guitar	E	B	G	D	A	E	B
Bass	G	D	A	E	B		
Open A	E	C#	A	E	A	E	
Open D	D	A	F#	D	A	D	
Open E	E	B	G#	E	B	E	
Open G	D	B	G	D	G	D	
DADGAD	D	A	G	D	A	D	



Using the metronome

Use the metronome to count in before recording or as a click track.

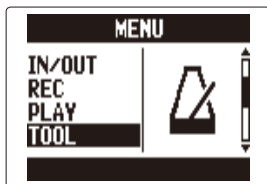

1. Press .

2. Use  to select "TOOL", and press .



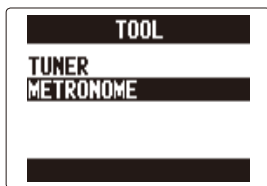

3. Use  to select "METRONOME", and press .

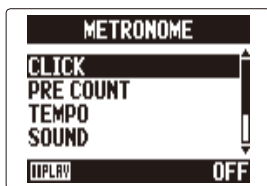

4. Use  to select a menu item, and press .



■ Set the "CLICK"

Use  to set when the metronome is active, and press .





HINT

CLICK has the following options.

OFF:	Sound off
REC AND PLAY:	Sound on during recording/playback
REC ONLY:	Sound on during recording only
PLAY ONLY:	Sound on during playback only

■ Set the "PRE COUNT" (→ P. 30)

■ Set the "TEMPO"

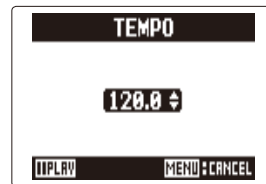

Use  to set the metronome speed, and press .



HINT

TEMPO can be set from 40.0 to 250.0.

■ Set the "SOUND"



Use  to set the metronome sound, and press .



HINT

SOUND has the following options.
BELL, CLICK, STICK, COWBELL, HI-Q

■ Set the "PATTERN"

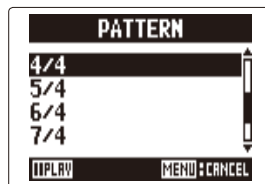

Use  to select the metronome pattern, and press .



HINT

PATTERN has the following options.
0/4 – 8/4, 6/8

■ Set the "LEVEL"

Use  to adjust the metronome volume, and press .

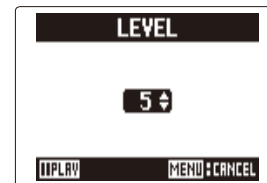

HINT

The LEVEL range is 0 – 10.

NOTE

- This cannot be used at the same time as the AUTO REC function. When AUTO REC is turned ON, the metronome will be disabled.
- This cannot be used at the same time as the PRE REC function. When METRONOME is turned ON, PRE REC will be disabled.

HINT



On any metronome setting screen, press  to listen to the current metronome setting.

Adjusting the input signal monitoring mix

MULTI FILE mode only

You can adjust the level and panning of each input signal when monitoring.

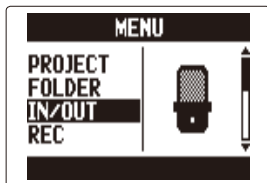

1. Press .

2. Use  to select "IN/OUT", and press .

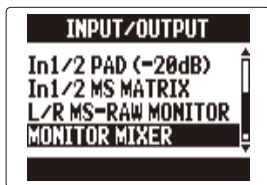

3. Use  to select "MONITOR MIXER", and press .



4. Use  to select the track to adjust, and press .

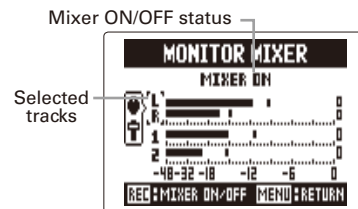

5. Change parameter values.

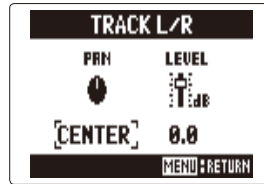

■ Mixing controls

Move cursor/change value: Move  up/down

Select parameter to change: Press 

Parameter	Setting range	Explanation
PAN	L100 – CENTER – R100	Adjusts left-right balance
LEVEL	Mute, -48.0 – +12dB	Adjusts volume

NOTE

These volume and panning settings only affect the monitoring signal. They do not affect recorded data.

6. Press  to listen to the project without mixer adjustments.

Pressing this button turns the mixer on and off.

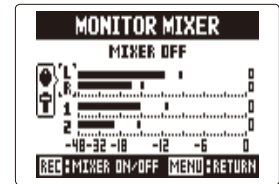



NOTE

These mix settings are saved with each recorded project separately. Mix settings can also be changed during playback. (→ P. 48)

Lowering the line output level

You can lower the output level of the LINE OUT jack. Use this when connecting the LINE OUT jack signal to the external mic input jack on an SLR camera or other jack with a high input gain.

1. Press .

2. Use  to select "IN/OUT", and press .

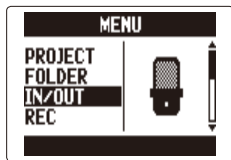

MULTI FILE mode

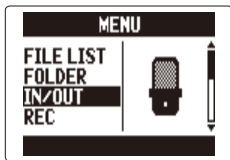

STEREO FILE mode

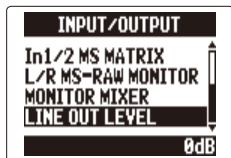

3. Use  to select "LINE OUT LEVEL", and press .

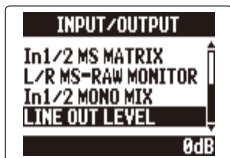

MULTI FILE mode



STEREO FILE mode

4. Use  to set the LINE OUT jack output level, and press .

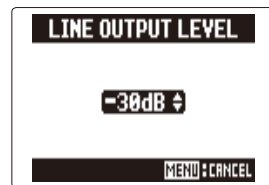

NOTE

This setting does not affect the level output from the PHONE jack.



HINT

LINE OUT LEVEL can be set between -30 and 0 dB.

Monitoring MS-RAW signals MS-RAW mode only

When recording in MS-RAW mode with an MS capsule, you can monitor the mid mic input through the left channel and the side mic input through the right channel as is.

1. Press .

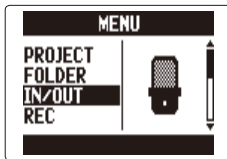

2. Use  to select "IN/OUT", and press .



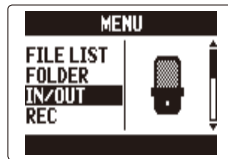

MULTI FILE mode

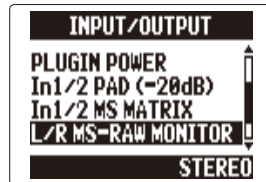

STEREO FILE mode

3. Use  to select "L/R MS-RAW MONITOR", and press .



4. Use  to select "RAW", and press .

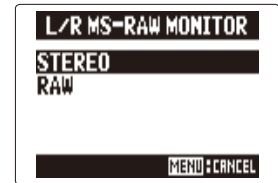

NOTE



Select "STEREO" if you want to monitor with an ordinary stereo mix.

Converting input MS signals to stereo

Input 1/2 only

This unit can convert MS stereo mic signal input through Inputs 1/2 into ordinary L/R stereo signals.

1. Press .

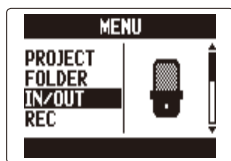

2. Use  to select "IN/OUT", and press .



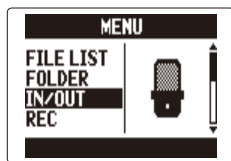

MULTI FILE mode

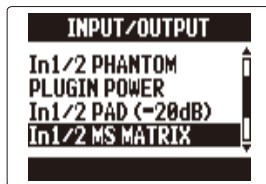

STEREO FILE mode

3. Use  to select "In1/2 MS MATRIX", and press .



4. Use  to select an item, and press .

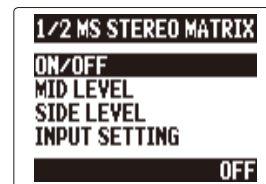

■ Turn "ON/OFF"

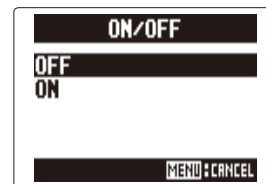

Use  to select "ON", and press .



NOTE

- When ON, tracks 1/2 will be reconfigured as a stereo track.
- This function cannot be used at the same time as the MONO MIX function. When MONO MIX is turned ON, MS STEREO MATRIX will be disabled.

■ Set "MID LEVEL"



Use  to set the level of the mid mic, which captures the center sound, and press .



HINT

MID LEVEL can be set to mute or in a range from -48.0 to +12.0 dB.

■ Set "SIDE LEVEL"



Use  to set the level of the side mic, which captures the sound to the left and right, and press .



HINT

SIDE LEVEL can be set to mute, or in a range from -48.0 to +12.0 dB.

■ Select "INPUT SETTING"

Use  to assign the MID and SIDE inputs to Inputs 1 and 2, and press .

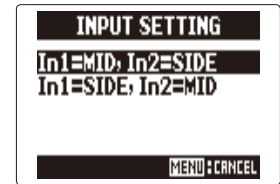



Mixing input signals to mono

STEREO FILE mode only



Input 1/2 only

The signals input through Inputs 1/2 can be mixed to a single signal that is sent to both channels.

1. Press .

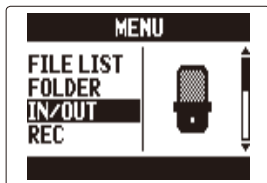
2. Use  to select "IN/OUT", and press .



3. Use  to select "In1/2 MONO MIX", and press .

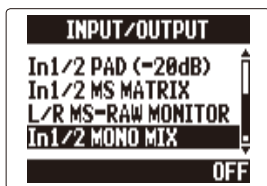

4. Use  to select "ON", and press .

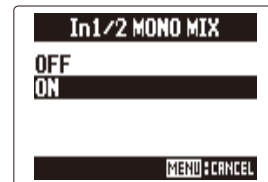



NOTE

- When MONO MIX is ON, the names of recording files will have "_MN" added to the end of the file name, like "ZOOM0001_MN.WAV".
- This function cannot be used at the same time as the MS STEREO MATRIX function. When MONO MIX is turned ON, MS STEREO MATRIX will be disabled.

Setting the recording format

Select the format according to the desired audio quality and file size.

1. Press .

2. Use  to select "REC", and press .

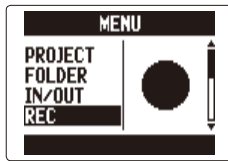

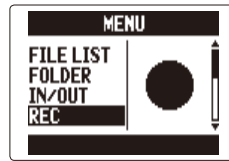

MULTI FILE mode

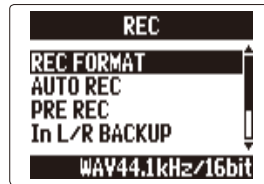

STEREO FILE mode

3. Use  to select "REC FORMAT", and press .



4. Use  to select recording format, and press .

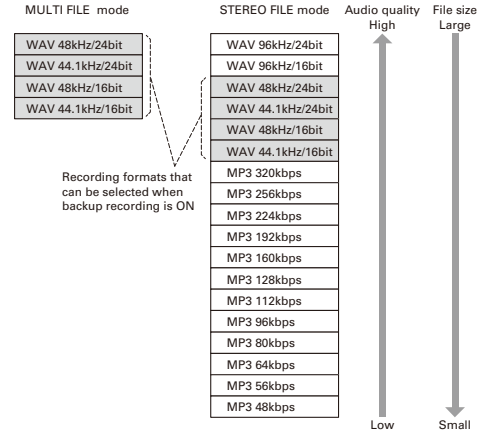

NOTE



- Use the WAV format for recording high-quality audio.
- The MP3 format reduces file size through compression, but this also reduces the audio quality. Use this format if you need to conserve space or store many recordings on an SD card, for example.
- When using the backup recording function in STEREO FILE mode, some formats cannot be selected.

Changing automatic recording settings

You can set the input levels that cause automatic recording to start and stop, as well as the automatic stop time.

Setting the automatic recording start level

1. Press .

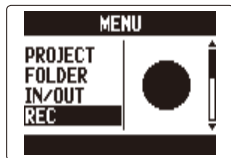

2. Use  to select "REC", and press .



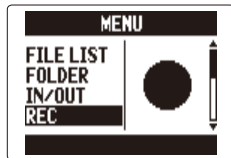

MULTI FILE mode



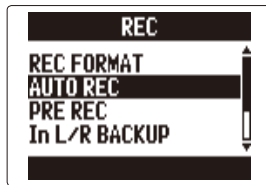

STEREO FILE mode

3. Use  to select "AUTO REC", and press .

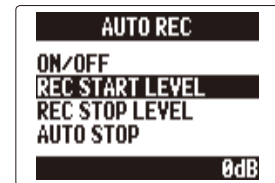

4. Use  to select "REC START LEVEL", and press .



5. Use  to set the start level, and press .

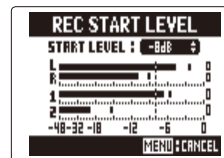

MULTI FILE mode

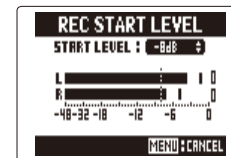







STEREO FILE mode

Recording will start automatically when the input level exceeds the set level.







HINT

This level can be set between -48 and 0 dB.

Setting automatic stopping

1. If you want recording to stop automatically, press    to select "AUTO STOP", and press   .



2. Use    to select the stop time, and press   .

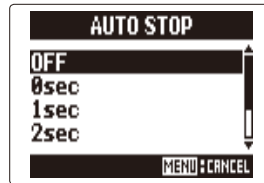

HINT

This can be set to OFF or from 0 to 5 seconds.

3. Set the stop level in the same manner as the start level.

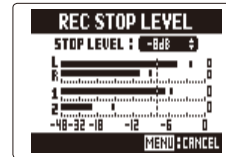

MULTI FILE mode

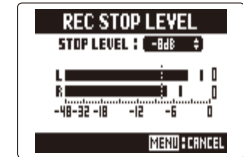



STEREO FILE mode

When the input level goes below the set level, recording will stop automatically after the amount of time set in step 2 above.

Setting how projects/files are named

You can change the type of name that is automatically given to projects/files.

1. Press .

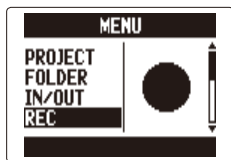

2. Use  to select "REC", and press .

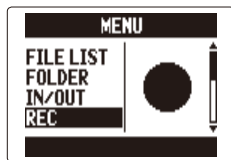

MULTI FILE mode



STEREO FILE mode

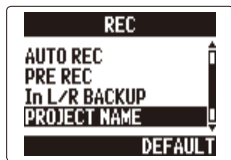

3. Use  to select "PROJECT NAME"/"FILE NAME", and press .



MULTI FILE mode



STEREO FILE mode

4. Use  to select the type, and press .

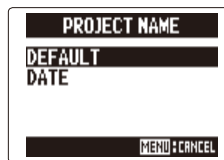

MULTI FILE mode

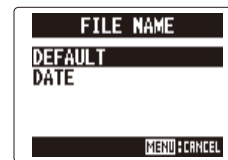

STEREO FILE mode



NOTE

- Project names are given in the following ways.
DEFAULT: ZOOM0001 - ZOOM9999
DATE: YYMMDD-HHMMSS (example: 140331-123016)
- File names are given in the following ways.
DEFAULT: ZOOM0001.WAV/MP3 - ZOOM9999.WAV/MP3
DATE: YYMMDD-HHMMSS.WAV/MP3
(example: 140331-123016.WAV/MP3)
- DATE format uses the starting time of the recording.
- In MULTI FILE mode, you cannot change how file names are given.

Reducing noise (low cut filter)

Use the low-cut filter to reduce wind noise and vocal pops, for example.

1. Press .

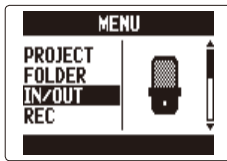

2. Use  to select "IN/OUT", and press .



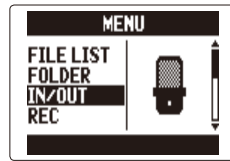

MULTI FILE mode

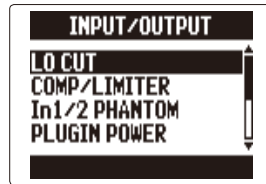

STEREO FILE mode

3. Use  to select "LO CUT", and press .



4. Use  to select the track to use it on, and press .

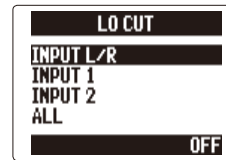

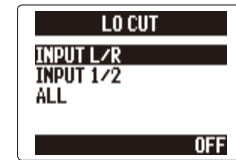

MULTI FILE mode



STEREO FILE mode

HINT

Set this to ALL to use the low-cut filter on all inputs at once.

5. Use  to select the cutoff frequency, and press .

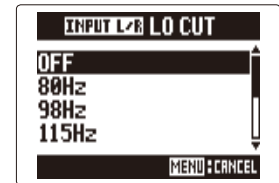



NOTE

The LO CUT filter is not used on backup recordings.

Adjusting the input level (compressor/limiter)

The unit can automatically raise low-level input signals and lower high-level input signals.

1. Press .

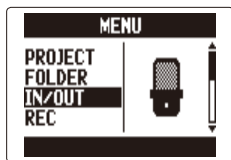

2. Use  to select "IN/OUT", and press .

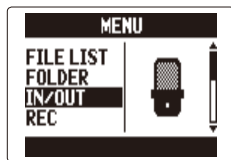

MULTI FILE mode



STEREO FILE mode

3. Use  to select "COMP/LIMITER", and press .

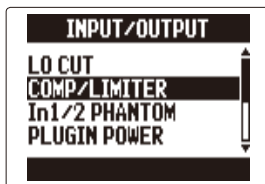

4. Use  to select the Input to adjust, and press .

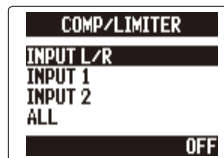



MULTI FILE mode



STEREO FILE mode

HINT

Select ALL to use this on all the inputs at once.

5. Use  to select the COMP/LIMITER type, and press .

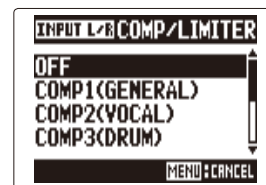

NOTE



The COMP/LIMITER is not used on backup recordings.

Setting	Explanation		Threshold (dB)	Ratio	Output level (dB)	Attack time (ms)	Release time (ms)
OFF	Compressor/limiter OFF		-	-	-	-	-
COMP (GENERAL)	Standard compressor	Compressors reduce high levels and raise low levels.	-48.7	9:1	+6.0	7.2	968
COMP (VOCAL)	Compressor for vocals		-8.4	16:1	0	1.8	8.7
COMP (DRUM)	Compressor for drums and percussion		-48.2	7:1	+3.6	12.3	947
LIMITER (GENERAL)	Standard limiter	Limiters reduce the level when input signals exceed a set level.	-14.4	60:1	0	6.4	528
LIMITER (CONCERT)	Limiter for live performances		-13.8	32:1	+1.2	1.9	8.5
LIMITER (STUDIO)	Limiter for studio recording		-12.0	8:1	+1.2	6.5	423

Changing the phantom power setting

Input 1/2 can provide phantom power of +12V, +24V or +48V.

1. Press .

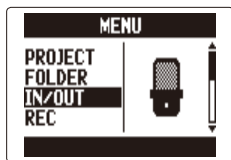

2. Use  to select "IN/OUT", and press .



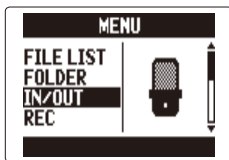

MULTI FILE mode



STEREO FILE mode

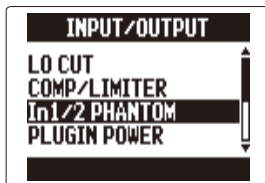

3. Use  to select "In1/2 PHANTOM", and press .

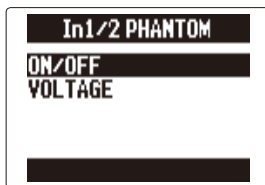

4. Use  to select an item, and press .



■ Turning "ON/OFF"

Use  to select an input, and press .

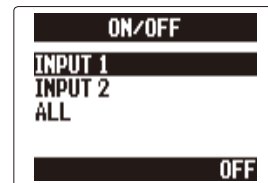



HINT

Select ALL to use phantom power on both inputs.

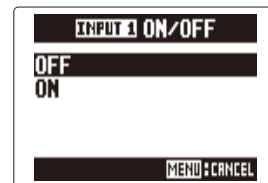
Use  to select "ON", and press .



■ Set the "VOLTAGE"

Use  to select the voltage, and press .

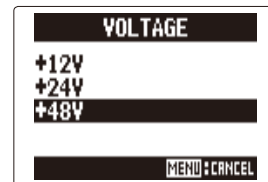



HINT

If a condenser mic can be used with less than +48V, lowering the voltage will reduce the amount of power that the **H5** uses.

Using plug-in power

When using a mic that uses plug-in power, make the following setting before connecting it to the **MIC/LINE** input jack of the **XY mic**.

1. Press  MENU

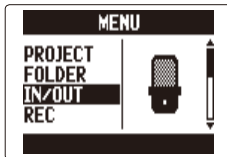

2. Use  to select "IN/OUT", and press .



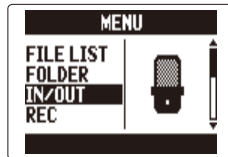

MULTI FILE mode

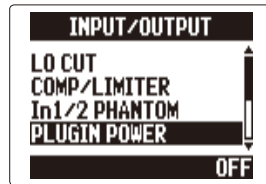

STEREO FILE mode

3. Use  to select "PLUGIN POWER", and press .



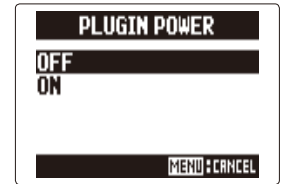

4. Use  to select "ON", and press .



Reducing the input signal level Input 1/2 only

When connecting a mixer with a standard output level or +4dB, for example, you can set this unit to reduce the input signal level -20 dB.

1. Press .

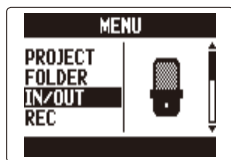

2. Use  to select "IN/OUT", and press .



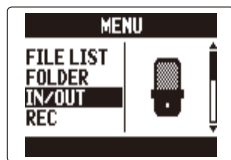

MULTI FILE mode

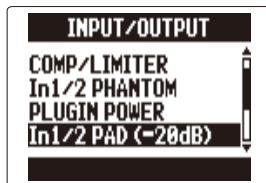

STEREO FILE mode

3. Use  to select "In1/2 PAD (-20dB)", and press .



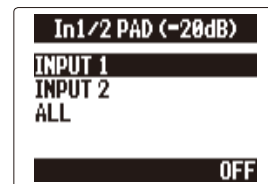

4. Use  to select the input, and press .



HINT

Select ALL to use the pad on both inputs.

5. Use  to select "ON", and press .

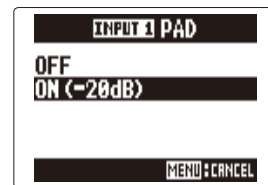



Setting the counter

Set how time is shown during recording

You can set the counter to show either the elapsed recording time (count up) or the remaining possible recording time (count down).

1. Press .

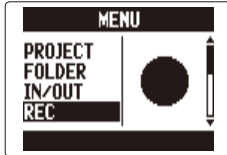

2. Use  to select "REC", and press .



MULTI FILE mode



STEREO FILE mode



3. Use  to select "COUNTER SETUP", and press .



MULTI FILE mode



STEREO FILE mode

4. Use  to select how the counter appears, and press .





NEXT >>>

Setting the counter (continued)



Set how time is shown during playback

You can set the counter to show either the elapsed playback time (count up) or remaining playback time (count down).

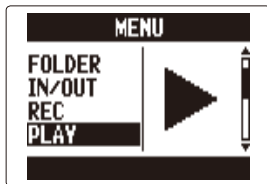

1. Press .

2. Use  to select "PLAY", and press .



3. Use  to select "COUNTER SETUP", and press .





4. Use  to select how the counter appears, and press .





Changing the display backlight setting

You can set the display backlight to turn off when no operation is conducted for 30 seconds in order to save power.

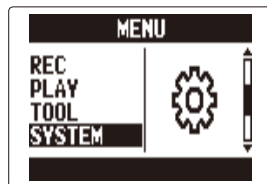

1. Press .

2. Use  to select "SYSTEM", and press .

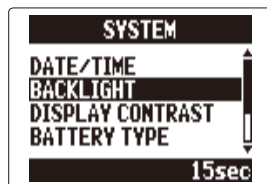

3. Use  to select "BACKLIGHT", and press .



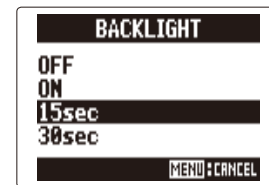

4. Use  to change the setting, and press .





Adjusting the display contrast

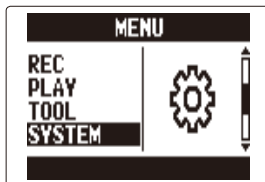

1. Press .

2. Use  to select "SYSTEM", and press .

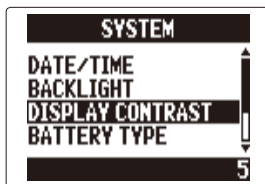

3. Use  to select "DISPLAY CONTRAST", and press .



4. Use  to adjust the contrast, and press .

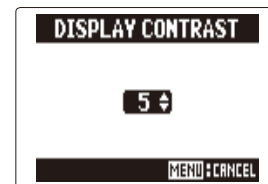



HINT

This can be set between 1 and 10.



Checking the firmware versions

You can check the software versions used by the **H5**.

1. Press .

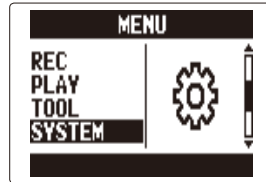
2. Use  to select "SYSTEM", and press .



3. Use  to select "FIRMWARE VERSION", and press .

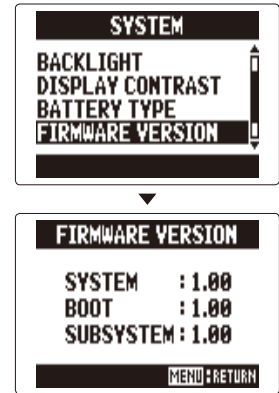

The firmware versions will be shown.





Restoring the default settings

You can restore the unit to its factory default settings.

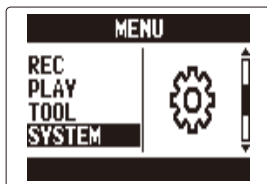

1. Press .

2. Use  to select "SYSTEM", and press .

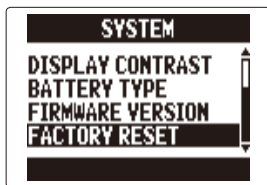

3. Use  to select "FACTORY RESET", and press .



4. Use  to select "YES", and press .





This will restore the default settings. The unit will automatically turn off.

NOTE



Input level settings are not reset.

Checking SD card open space

1. Press .

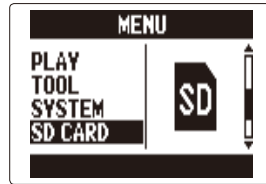
2. Use  to select "SD CARD", and press .



3. Use  to select "REMAIN", and press .

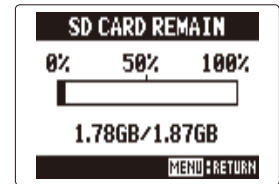
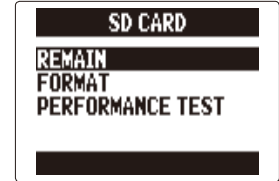

The amount of remaining open space will be shown.





Formatting SD cards

Follow these procedures to format an SD card for use with the **H5**.

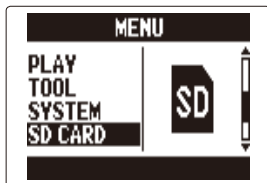

1. Press .

2. Use  to select "SD CARD", and press .

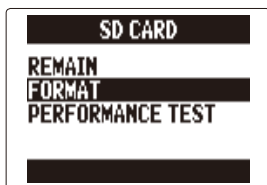

3. Use  to select "FORMAT", and press .



4. Use  to select "YES", and press .

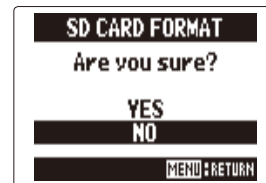

NOTE



- If you use an SD card that has been formatted by a computer or that you have purchased, you must format it using the **H5** before use.
- Be aware that all data previously saved on the SD card will be deleted when it is formatted.

Testing SD card performance



You can test SD cards to confirm that they can be used with the **H5**.
The quick test takes very little time, while the full test examines the entire SD card.

Conducting a quick test

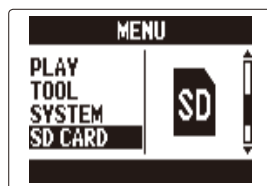

1. Press .

2. Use  to select "SD CARD", and press .



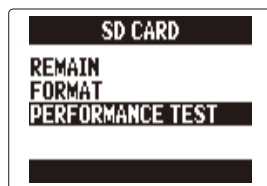

3. Use  to select "PERFORMANCE TEST", and press .

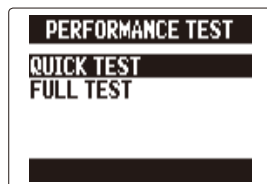

4. Use  to select "QUICK TEST", and press .



5. Use  to select "YES", and press .

The card performance test, which takes about 30 seconds, will start.

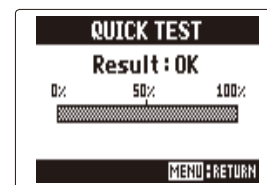

NEXT >>>



Testing SD card performance (continued)

6. To cancel testing, press .



NOTE

Even if an SD card is evaluated as "OK" by the performance test, this does not guarantee that write errors will never occur. Please use this test just as a guide.

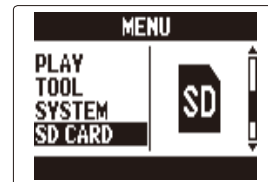

Conducting a full test

1. Press .
2. Use  to select "SD CARD", and press .



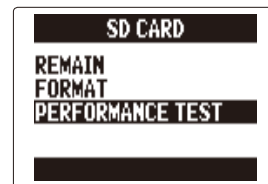



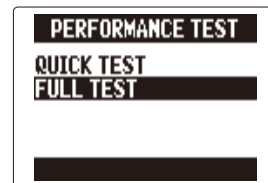

3. Use  to select "PERFORMANCE TEST", and press .





4. Use  to select "FULL TEST", and press .

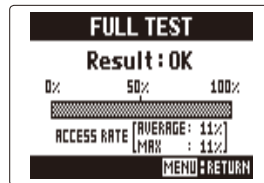
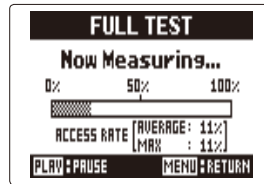

5. When the amount of time required is shown, use    to select "YES", and press   .



When the test completes, if the MAX access rate is 100%, the card has failed the test (NG).

6. To cancel testing, press  .

HINT

You can also press  to pause and resume testing.

NOTE

Even if an SD card is evaluated as "OK" by the performance test, this does not guarantee that write errors will never occur. Please use this test just as a guide.

Updating the firmware



The **H5** firmware can be updated to the latest versions.

1. Copy the version update file to the root directory of the SD card.

NOTE

You can download the file for the latest firmware version update from the ZOOM website (www.zoom.co.jp).

2. Insert the SD card into the **H5**. Then, turn it on while pressing .

3. Use  to select "YES", and press .



NOTE

Do not turn the power off or remove the SD card during a firmware version update. Doing so could make the **H5** unstartable.

4. After the firmware update completes, turn the power off.









NOTE

Updating the firmware is not possible when the remaining battery power is too low. If this is the case, install new batteries or use an AC adapter.

Using SD cards from older H series recorders

An SD card that has been used in an older ZOOM H series recorder can be read by an **H5** and its files moved for its use.

1. Insert the SD card, and then turn the **H5** on.

2. Use    to select "YES", and press   .



NOTE

- This function cannot be used to move projects created by an **H6**.
- When files created in 4CH MODE are moved, a project named "ZOOMXXXX" will be created.
- Moved files will have the name of the H series model that they came from added to the beginnings of their names.
- If a file with the same name already exists on the destination, movement will not be possible until the file name is changed.

Using a remote control

You can operate the **H5** from a distance by using a remote control.

1. Connect the remote control to the **H5** REMOTE jack.

The buttons on the remote control correspond to the buttons on the **H5** main unit.

HINT

The remote control buttons can be used even when the **H5** hold function is active.

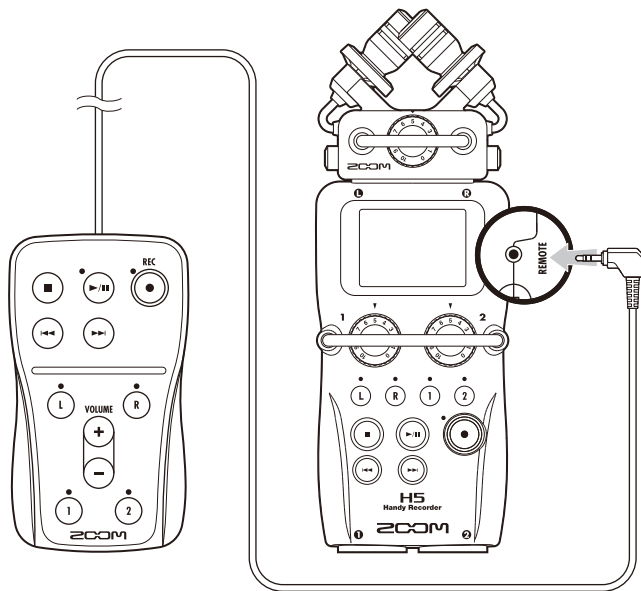

Troubleshooting

If you think that the **H5** is not operating properly, please check the following first.

Recording/playback trouble

◆ There is no sound or output is very quiet

- Check the connections to your monitoring system and its volume setting.
- Confirm that the volume of the **H5** is not too low. (→ P. 39)

◆ The sound from a connected device or mic cannot be heard or is very quiet

- If you are using the included XY mic, confirm that the mic orientation is suitable.
- Check the input level setting. (→ P. 22)
- If connecting a CD player or other device to an input jack, try raising the output level of that device.
- Check the input signal monitoring setting. (→ P. 82)
- Check the plug-in power setting. (→ P. 97)
- Check the PAD function setting. (→ P. 98)

◆ Recording is not possible

- Confirm that a track button is lit red.
- Confirm that the SD card has open space. (→ P. 105)
- Confirm that an SD card is loaded correctly in the card slot.
- If “Card Protected” Appears, the SD Card write-protection is on.
Slide the lock switch to turn write-protection off.
- If “Hold” appears on the display, the hold function is enabled.
Disable the hold function. (→ P. 15)

◆ The recorded sound cannot be heard or is very quiet

- Confirm that the volume levels of the L/R and 1/2 tracks are not turned down. (→ P. 48)
- Confirm that the track buttons are lit green during playback.

◆ Mixing down is not possible (MULTI FILE mode)

- Confirm that the volume levels of the L/R and 1/2 tracks are not turned down. (→ P. 48)
- Confirm that the SD card has open space. (→ P. 105)

Other trouble

◆ Not recognized by a computer when connected by USB

- Check that the OS of the computer is compatible. (→ P. 70)
- An operation mode must be selected on the **H5** to allow a computer to recognize it. (→ P. 70)

Specifications

Recording media		16MB–2GB SD cards, 4GB–32GB SDHC cards	
Inputs	L/R inputs	XY mic (XYH-5)	
		Mic type	Directional
		Sensitivity	–45 dB, 1 kHz at 1 Pa
		Input gain	–∞ to 52 dB
		Maximum sound pressure input	140 dB SPL
		MIC/LINE IN stereo mini jack	Input gain: –∞ to 52 dB Input impedance: 2 kΩ or more Plug-in power supported
	1/2 INPUTS	Backup input	Set L/R input gain –12 dB
		Connectors	XLR/TRS combo jacks (XLR: 2 hot, TRS: TIP hot)
		Input gain (PAD OFF)	–∞ to 55 dB
		Input gain (PAD ON)	–∞ to 35 dB
		Input impedance	1.8 kΩ or more
		Maximum allowable input level	+22 dBu (PAD ON)
		Phantom power	+12/+24/+48 V (can be turned ON/OFF independently for INPUTS 1/2)
		Equivalent input noise (EIN)	–120 dBu or less
Out-puts	Output jacks	LINE OUT stereo mini jack (rated output level –10 dBm when output load impedance is 10 kΩ or more) PHONE OUT stereo mini jack (20 mW + 20 mW into 32Ω load)	
	Built-in speaker	400mW/8Ω mono speaker	
	Recording formats	STEREO FILE mode Supported WAV formats: 44.1/48/96kHz, 16/24-bit, stereo, BWF format supported Supported MP3 formats: 48–320 kbps, 44.1kHz sampling frequency Maximum simultaneous recording tracks 4 tracks (L/R + backup recording) MULTI FILE mode Supported formats: 44.1/48kHz, 16/24-bit, mono/stereo, BWF format supported Maximum simultaneous recording tracks 6tracks (L/R + 1/2 +backup recording)	
Display	LCD (128 x 64) with backlight		

USB	Mass storage class operation	
	Class: USB 2.0 High Speed	
	Audio interface operation: MULTI TRACK mode (Note: Use with Windows requires a driver, but Mac OS does not)	
	Class: USB 2.0 High Speed	
	Specifications: 4 in/2 out, 44.1/48kHz sampling rate, 16/24-bit bit rate	
	Audio interface operation: STEREO mode (no driver required)	
	Class: USB 2.0 Full Speed	
	Specifications: 2 in/2 out, 44.1/48kHz sampling rate, 16-bit bit rate	
	Note: Use as an iPad audio interface supported (STEREO mode only)	
	Note: USB bus power operation possible	
Approximate continuous operation times when recording using battery power (in hours and minutes)	STEREO FILE mode	
	XY mic, 44.1kHz/16-bit (stereo x 1):	about 15 hours
Power	MULTI FILE mode	
	XY mic, Inputs 1 and 2, 48kHz/24-bit (stereo x 2):	about 7 hours 10 minutes
	Note: The above times are estimates. Note: Approximate continuous recording times when using battery power were calculated using our own testing method. They may differ greatly depending on operating conditions.	
Dimensions	Operates using 2 AA batteries	
	AC adapter : DC5V 1A AD-17	
	USB bus power	
Dimensions	Main unit: 66.8 mm (W) × 135.2 mm (D) × 42.1 mm (H), 176 g	
	XYH-5: 65.5 mm (W) × 62.2 mm (D) × 41.0 mm (H) 94 g	

FCC regulation warning (for U.S.A.)

This equipment has been tested and found to comply with the limits for a Class B digital device, pursuant to Part 15 of the FCC Rules. These limits are designed to provide reasonable protection against harmful interference in a residential installation. This equipment generates, uses, and can radiate radio frequency energy and, if not installed and used in accordance with the instructions, may cause harmful interference to radio communications. However, there is no guarantee that interference will not occur in a particular installation. If this equipment does cause harmful interference to radio or television reception, which can be determined by turning the equipment off and on, the user is encouraged to try to correct the interference by one or more of the following measures:

- Reorient or relocate the receiving antenna.
- Increase the separation between the equipment and receiver.
- Connect the equipment to an outlet on a circuit different from that to which the receiver is connected.
- Consult the dealer or an experienced radio/TV technician for help.

For EU Countries



Declaration of Conformity:
This product complies with the requirements of
EMC Directive 2004/108/EC and
Low Voltage Directive 2006/95/EC and
ErP Directive 2009/125/EC and
RoHS Directive 2011/65/EU

ZOOM

ZOOM CORPORATION

4-4-3 Surugadai, Kanda, Chiyoda-ku, Tokyo
101-0062 Japan
<http://www.zoom.co.jp>